

# arteferro

WROUGHT IRON  
CATALOGUE

CATÁLOGO  
HIERRO FORJADO



DESCARGUE NUESTRA  
TARIFA DE PRECIOS





El catálogo, y todas sus partes, son tutelados por la ley sobre los derechos a autor. Queda absolutamente prohibido, y será sancionado, cualquier reproducción total o parcial de él. IND.I.A ESPAÑA posee el derecho de CopyRight

The catalogue, including all its parts, is under copyright law. Any reproduction in any way and form (including photocopies, scans, electronic storages) and communication (including for example: the distribution, the adjustment, the translation and the revision, also through digital interactive channels and any other mode currently known or developed in future) is forbidden and sanctioned (if not clearly authorised).



Nos reservamos el derecho a aportar variaciones técnicas de fabricación y dimensiones a los productos. Los productos originales pueden diferir ligeramente de las representaciones fotográficas. A este propósito no será aceptado ningún reclamación.

We reserve the right to make technical changes of the production process and of the article's dimensions. The original item can slightly differ from its picture. Hence no claims can be accepted in this regard.



Ind.i.a. spa no se hará responsable jurídicamente por eventuales erratas de imprenta.  
Ind.i.a. spa disclaims any legal liability not legally foreseen for printing mistakes



Tanto la cantidad de reembolso máximo prevista como la reclamación por daños y perjuicios debe remitirse exactamente al valor de los bienes devueltos intactos.

The max reimbursement amount foreseen as claim for damages is to be referred to the value of intact goods



Se ruega tener en cuenta las normas legales aplicables en las distintas regiones o países.  
You are kindly requested to observe the directives applied in the different areas/countries.



Los precios indicados son netos por unidad, embalaje incluido. Todos los precios excluyen el IVA.  
The prices are net per unit, packaging included. All prices are exempt of VAT.



Por cada artículo está prevista una confección mínima indicada en el listado. Eventuales órdenes por cantidades que difierenan de la confección mínima, o a múltiplos de ella, podrán ser automáticamente incrementados por la empresa sin previa autorización.

For each item a minimum packaging unit is foreseen, as indicated in the price-list. In case of orders with different quantities than those of the minimum packaging or multiple of it, the company can adjust them automatically without prior authorisation.



Si applicano le nostre condizioni generali di vendita

Our general sales conditions will be applied

Le condizioni di vendita le potete trovare sul sito

Our sales conditions can be read in our website

Condiciones de venta en nuestro catálogo

Conditions de vente dans notre catalogue

[www.gonzatogroup.com/sales\\_conditions.html](http://www.gonzatogroup.com/sales_conditions.html)

# The best in wrought iron

## Il meglio del ferro battuto



Arteferro is a division of Gonzato Group dedicated to the production of semifinished elements in wrought iron, brass and bronze. The Arteferro product line includes over 32,000 semi-finished ornamental items made of wrought iron, brass, and bronze: pierced bars, forged pickets, pre-assembled panels, leaves, flowers, baskets, roses, scrolls, rings, and other decorative elements, as well as a rich variety of home furnishings. It is the task of blacksmiths to assemble them into finished objects such as railings, fences, or any other creation suggests his creativity. Arteferro also includes the Arteferro System product line, which is characterized by an elegant and innovative style.

Arteferro è la divisione di Gonzato Group dedicata alla produzione di elementi semilavorati in ferro battuto, ottone e bronzo. La gamma di prodotti Arteferro comprende oltre 32.000 elementi: barre forate, paletti forgiati, pannelli preassemblati, foglie, fiori, pigne, rosoni, ricci, cerchi ed altri componenti decorativi, oltre ad una ricca serie di complementi d'arredo. Sarà compito del fabbro assemblarli in oggetti finiti come parapetti, recinzioni o qualsiasi altra creazione gli suggerisca la sua creatività. Arteferro comprende anche la linea di prodotti Arteferro System, caratterizzata da uno stile elegante ed innovativo.



# THE GROUP

/ EL GRUPO



**GONZATO**  
GROUP

**GONZATO GROUP ITALIA**

WORLDWIDE

**Gonzato Group** Texas / **Gonzato Group** Florida /  
**Gonzato Group** Brasil / **Gonzato Group** Mexico /  
**Gonzato Group** Russia / **Gonzato Group** Argentina /  
**Gonzato Group** Chile / **Gonzato Group** China

EUROPEAN

**Gonzato Group** Italia / **Gonzato Group** France /  
**Gonzato Group** España / **Gonzato Group** Croatia /  
**Gonzato Group** Romania

**WM**  
DESIGN

**arteferro**

**A Brand of Gonzato Group**

## An ever growing presence.

- 13 branches in 5 continents and headquarter in Italy 5 production sites totalling
- 64.000 Sq. Mt. of warehousing and production
- Over 500 employees (2021)
- 16 Subsidiarie with stocking facilities worldwide
- 4.100 ton./month shipped
- 40 million pieces of ready made components sold per year
- Over 2000 stockist customers served, in 136 different Countries
- Over 32.000 components available on stock
- A 5 continents' leadership
- Exports to 136 countries
- A product range of over 30.000 items

## Certifications

Quality certified ISO 9001 Environmental Certification ISO 14001.

## Una realidad en continuo crecimiento

- 13 sedes distribuidas a través de 5 continentes.
- Sede central en Italia y 5 plantas productivas.
- 64.000 m2
- 16 filiales con distribución a nivel mundial
- 4.100 ton./mes expedidas.
- 40 millones de productos semi-terminados vendidos de media en un año.
- Más de 2.000 clientes mayoristas distribuidos por 136 estados a nivel mundial.
- Más de 32.000 artículos diferentes en stock.
- Posición de Liderazgo en los 5 continentes.
- Presente en 136 estados.
- Gama de otros 30.000 artículos.

## Certificados

Un sistema de calidad certificado por la ISO 9001 y el Certificado Medioambiental de la ISO 14001.



The Gonzato Group España is the first historical branch established in 1989. We serve the whole Iberian market and we currently have 1049 sqm of warehouse and 11 employees and agents. Our strength is the large availability of stock material in iron and stainless steel. We are in close contact with the headquarter in Italy which is a leader in the field of semi-finished products and modular iron systems for the building and architecture sector.

La sucursal del Gonzato Group España es la primera sucursal histórica establecida en 1989. Atendemos todo el mercado ibérico y actualmente disponemos de 1049m<sup>2</sup> de almacén y 11 empleados y agentes. Nuestro punto fuerte es la gran cantidad y variedad de stock en hierro y acero. Tenemos un contacto estrecho con la sede central de Italia, líder en el sector de productos semiacabados y sistemas de hierro modulares para el sector de la construcción y la arquitectura.



Cod.art.	Pag.	Cod.art.	Pag.	Cod.art.	Pag.	Cod.art.	Pag.	Cod.art.	Pag.	Cod.art.	Pag.
16/1	62	64/h/9	18	114/10	9	136/3	69	812/2	8	GD76/1	47
16/2	62	64/L/3	21	114/5	9	136/4	69	812/6	8	GD76/2	47
20/5	62	64/L/4	21	114/9	9	137/7	69	819/1	67	GD99/1	52
26/C/1	63	70/D/1	23	114/9	70	137/8	69	1054/4	19	GD150/2	53
31/1	63	70/D/5	28	114/9	71	138/10	69	1122/1	27	GD150/3	53
34/1	63	74/10	64	114/A/3	8	138/8	69	1122/3	27	GD151/1	53
42/11/SAB	10	74/14	64	114/B/13	8	138/9	69	1148/3/S	16	GD151/2	53
42/15/SAB	10	74/15	64	114/B/13	71	140/H/1	69	1148/5	16	GD158/2	55
42/16/SAB	10	74/16	64	114/B/14	8	140/H/2	69	1148/5	70	GD176/1	39
42/18/SAB	10	74/2	64	116/10	9	148/2	28	1148/6	16	GD176/2	39
42/2/SAB	10	74/20	64	116/14	9	149/1	28	1148/6/S	16	GD176/3	39
42/22/SAB	10	74/21	64	116/2	9	157/1	66	1148/8	16	GD179/2	38
42/23/SAB	10	74/22	64	116/6	9	157/1	71	1148/8	70	GD205/1	49
42/25/SAB	10	74/3	64	116/A/19	68	157/2	66	1148/9	16	GD211/1	48
42/4/SAB	10	74/4	64	116/A/20	68	157/3	66	1148/9/S	16	GD222/1	40
42/8/SAB	10	74/8	64	116/A/20	71	157/6	66	1167/1	19	GD222/2	40
42/9/SAB	10	74/9	64	116/A/3	68	157/7	66	1167/2	19	GD223/1	40
42/A/10/SAB	10	78/10	64	116/A/4	68	157/8	66	1167/3	19	GD226/1	44
42/A/12/SAB	10	78/2	64	116/A/7	68	158/1	8	1167/4	19	GD226/2	44
42/A/14/S1/SAB	10	78/3	64	116/A/8	68	158/12/C	8	1177/7	21	GD226/3	44
42/A/14/S3/SAB	10	78/4	64	116/F/1	66	158/3	8	1177/8	21	GD226/4	44
42/A/14/SAB	10	78/8	64	116/F/2	66	158/6	8	1317/1	66	GD232/1	51
42/A/16/SAB	10	78/9	64	116/F/3	66	158/6	70	1317/2	66	GD234/2	63
42/A/16/SP3/SAB	10	80/A/1	64	116/F/4	66	158/6	71	1373/4	8	GD236/1	54
42/A/2/SAB	10	80/A/3	64	116/F/5	66	159/3	68	1374/1	7	GD268/2	41
42/A/4/SAB	10	80/A/9	65	116/F/6	66	159/4	68	1374/3	7	GD271/4	55
42/A/5/SAB	10	80/A/10	65	116/F/7	66	159/5	68	1374/3	70	GD271/5	55
42/A/6/SAB	10	80/A/11	65	116/F/8	66	159/6	68	1374/4	7	GD278/1	31
42/A/8/SAB	10	80/A/12	65	116/F/9	66	159/9	68	1374/9	7	GD278/2	31
42/A/9/SAB	10	80/A/24	65	116/F/10	66	180/50	7	1374/10	7	GD282/2	54
48/1	25	80/A/25	65	116/F/17	66	489/1	22	1374/11	7	GD283/1	48
48/2	25	80/A/26	65	116/F/19	66	489/2	22	1408/6	67	GD285/2	45
48/3	25	80/A/27	65	118/1	7	490/1	22	1671/3	26	GD287/1	30
48/4	25	80/A/28	64	118/1	70	490/2	22	1671/4	26	GD287/2	30
48/6	25	80/A/29	64	118/2	7	491/8	66	1680/2	49	GD287/3	30
48/7	25	88/H/2	65	118/24	7	497/1/C	14	1681/1	49	GD290/1	37
48/8	25	88/H/3	65	118/3	7	497/2/C	14	1817/5	8	GD291/1	46
48/8/SAB	71	88/H/4	65	118/A/1	7	499/1/C	14	1818/7	9	GD291/2	42
48/9	25	94/A/1	69	118/A/2	7	499/2/C	14	1818/8	9	GD293/1	30
49/3	27	94/A/2	69	118/A/3	7	505/3	15	1817/9	8	GD296/1	38
50/10	23	98/1	12	122/A/1	71	505/4	15	1818/11	9	GD299/1	32
50/11	23	99/1/C	12	122/A/1	61	508/3/C	15	1818/12	9	GD299/2	32
50/12	23	99/2/C	12	123/1	66	508/4/C	15	1838/2	9	GD299/3	32
50/5	23	105/1/C	12	124/1	61	511/1	27	1853/148	11	GD299/4	32
50/6	23	105/1/C	71	124/2	61	541/2	20	1853/148/S2	11	GD300/1	43
50/7	23	105/2/C	12	125/1	60	562/1	18	1853/40	11	GD300/2	43
50/8	23	105/2/C	71	125/1	70	562/2	18	1853/40/S1	11	GD300/3	43
50/9	23	108/A/1	15	125/1	71	576/2	18	1853/94	11	GD302/3	35
51/3	27	108/A/2	15	125/2	60	576/4	18	1853/94/S1	11		
52/1	26	112/10	13	126/1	60	578/15	17	1854/9	60		
52/2	27	112/11	13	126/1	70	697/4	68	1855/6	61		
52/A/3	27	112/5	13	126/13	60	715/1	29	GD16/2	50		
52/G/1	26	112/6	13	126/14	60	715/2	29	GD20/1	50		
64/F/1	17	112/7	13	126/2	60	716/1	29	GD20/2	50		
64/F/2	17	112/8	22	126/A/2	61	716/2	29	GD20/4	50		
64/F/3	17	112/8	71	126/B/1	61	716/3	29	GD20/5	50		
64/F/4	17	112/9	13	126/B/2	61	716/4	29	GD20/8	50		
64/F/5	17	113/1	24	126/B/3	61	720/1	29	GD23/1	51		
64/F/6	18	113/10	68	126/C/7	60	725/1	60	GD25/1	51		
64/F/7	18	113/2	24	128/2	67	727/10	61	GD38/1	34		
64/F/8	18	113/3	24	128/8	67	727/11	61	GD38/2	34		
64/F/9	18	113/4	24	128/19	67	797/1	22	GD40/1	34		
64/G/1	17	113/5	23	128/37	67	797/2	22	GD58/2	31		
64/G/2	17	113/6	23	134/4	21	797/5	22	GD58/3	31		
64/G/4	65	113/7	16	134/12	21	801/5	17	GD58/3	51		
64/G/5	65	113/8	16	136/1	69	802/1	20	GD61/1	52		
64/h/10	18	113/9	68	136/2	69	802/2	20	GD68/1	48		





Art.	Sección	Espesor	Largo
1374/9	30 x 20 mm	2,5 mm	3000 mm
1374/10	40 x 20 mm	2,5 mm	3000 mm
1374/11	50 x 30 mm	2,5 mm	3000 mm



Art.	Sección	Espesor	Largo
1374/1	20 x 20 mm	2,5 mm	3000 mm
1374/3	30 x 30 mm	2,5 mm	3000 mm
1374/4	40 x 40 mm	2,5 mm	3000 mm



Forjado 4 esquinas

Art.	Sección	Largo
118/1	12 x 12 mm	3000 mm
118/2	14 x 14 mm	3000 mm
118/3	16 x 16 mm	3000 mm
118/24	30 x 30 mm	3000 mm



Forjado 4 lados y 4 esquinas

Art.	Sección	Largo
118/A/1	12 x 12 mm	3000 mm
118/A/2	14 x 14 mm	3000 mm
118/A/3	16 x 16 mm	3000 mm
180/50	30 x 30 mm	3000 mm



Laminado en caliente



Art.	Sección	Largo
1373/4	40 x 11 mm	3000 mm
114/A/3	50 x 14 mm	3000 mm



Art.	Sezione	para pasamano
1817/9	40 x 11 mm	1373/4
114/B/13	50 x 14 mm	114/A/3

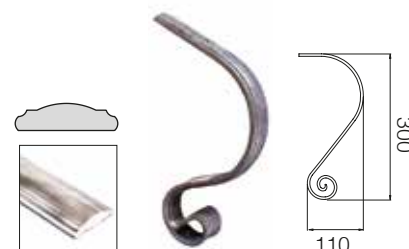

Art.	Sezione	para pasamano
1817/5	40 x 11 mm	1373/4
114/B/14	50 x 14 mm	114/A/3



Art.	Sección	Largo
158/12/C	40 x 8 mm	3000 mm



Art.	Sezione	para pasamano
812/6	40 x 8 mm	158/12/C

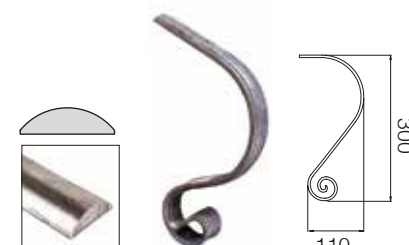

Art.	Sezione	para pasamano
812/2	40 x 8 mm	158/12/C

Perfiles laminados en caliente



Art.	Sección	Largo
158/1	14 x 4 mm	4000 mm



Art.	Sección	Largo
158/3	14 x 4 mm	4000 mm



Art.	Sección	Largo
158/6	14 x 4 mm	4000 mm





Laminado en frío



Art.	Sección	Largo
114/9	☒ 30 x 8 mm	3000 mm
1838/2	☒ 40 x 8 mm	3000 mm



Art.	Sezione	para pasamano
1818/11	☒ 30 x 8 mm	114/9
1818/12	☒ 40 x 8 mm	1838/2



Art.	Sezione	para pasamano
1818/7	☒ 30 x 8 mm	114/9
1818/8	☒ 40 x 8 mm	1838/2



Art.	Sección	Largo
114/10	☒ 40 x 8 mm	3000 mm



Art.	Sezione	para pasamano
116/14	☒ 40 x 8 mm	114/10



Art.	Sezione	para pasamano
116/6	☒ 40 x 8 mm	114/10



Art.	Sección	Largo
114/5	☒ 40 x 8 mm	3000 mm



Art.	Sezione	para pasamano
116/10	☒ 40 x 8 mm	114/5



Art.	Sezione	para pasamano
116/2	☒ 40 x 8 mm	114/10



TODAS LAS BARRAS SE ENTREGAN GRANALLADAS

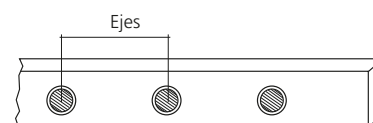
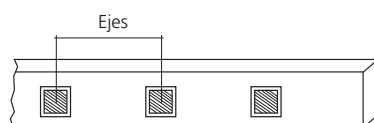

Barra perforada con agujero redondo

Sección	Agujero	Barra	Agujero	Ejes	Taladros	Art.
		Ø 16 mm	Ø 16 mm	150 mm	13	42/2/SAB
		Ø 16 mm	Ø 16 mm	126 mm	14	42/A/2/SAB
		Ø 20 mm	Ø 20 mm	170 mm	11	42/4/SAB
		Ø 20 mm	Ø 20 mm	130 mm	14	42/A/4/SAB



Barra perforada con agujero cuadrado

Sección	Agujero	Barra	Agujero	Ejes	Taladros	Art.
		14 mm	14 mm	140 mm	14	42/8/SAB
		14 mm	14 mm	124 mm	14	42/A/5/SAB
		16 mm	16 mm	150 mm	13	42/9/SAB
		16 mm	16 mm	126 mm	14	42/A/6/SAB
		20 mm	20 mm	170 mm	11	42/11/SAB
		20 mm	20 mm	130 mm	14	42/A/8/SAB



Barra perforada con agujero en rombo

Sección	Agujero	Barra	Agujero	Ejes	Taladros	Art.
		14 mm	14 mm	140 mm	14	42/22/SAB
		16 mm	16 mm	150 mm	13	42/23/SAB
		16 mm	16 mm	126 mm	14	42/A/14/SAB
		16 mm	16 mm	135 mm	14	42/A/14/S1/SAB
		16 mm	16 mm	125 mm	15	42/A/14/S3/SAB
		20 mm	20 mm	170 mm	11	42/25/SAB
		20 mm	20 mm	130 mm	14	42/A/16/SAB
		20 mm	16 mm	125 mm	14	42/A/16/SP3/SAB



Barra perforada con agujero en rombo en el canto

Sección	Agujero	Barra	Agujero	Ejes	Taladros	Art.
		14 mm	14 mm	125 mm	14	42/A/9/SAB
		14 mm	14 mm	140 mm	14	42/15/SAB
		16 mm	16 mm	150 mm	13	42/16/SAB
		16 mm	16 mm	126 mm	14	42/A/10/SAB
		20 mm	20 mm	170 mm	11	42/18/SAB
		20 mm	20 mm	130 mm	14	42/A/12/SAB



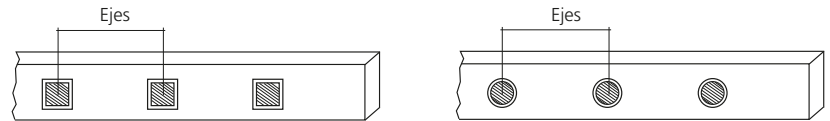

Barra perforada con agujero redondo. Disponibles en 3 metros

Sección	Agujero	Agujero	Ejes	Taladros	Art.
40 x 8 mm		16 mm	131 mm	14	1853/148
		20 mm	131 mm	14	1853/148/S2



Barra perforada con agujero cuadrado. Disponibles en 3 metros

Sección	Agujero	Agujero	Ejes	Taladros	Art.
40 x 8 mm		∅ 16 mm	131 mm	14	1853/40
		∅ 20 mm	131 mm	14	1853/40/S1



Barra perforada con agujero en rombo. Disponibles en 3 metros

Sección	Agujero	Agujero por	Ejes	Taladros	Art.
40 x 8 mm		∅ 16 mm	137,6 mm	14	1853/94
		∅ 20 mm	137,6 mm	14	1853/94/S1



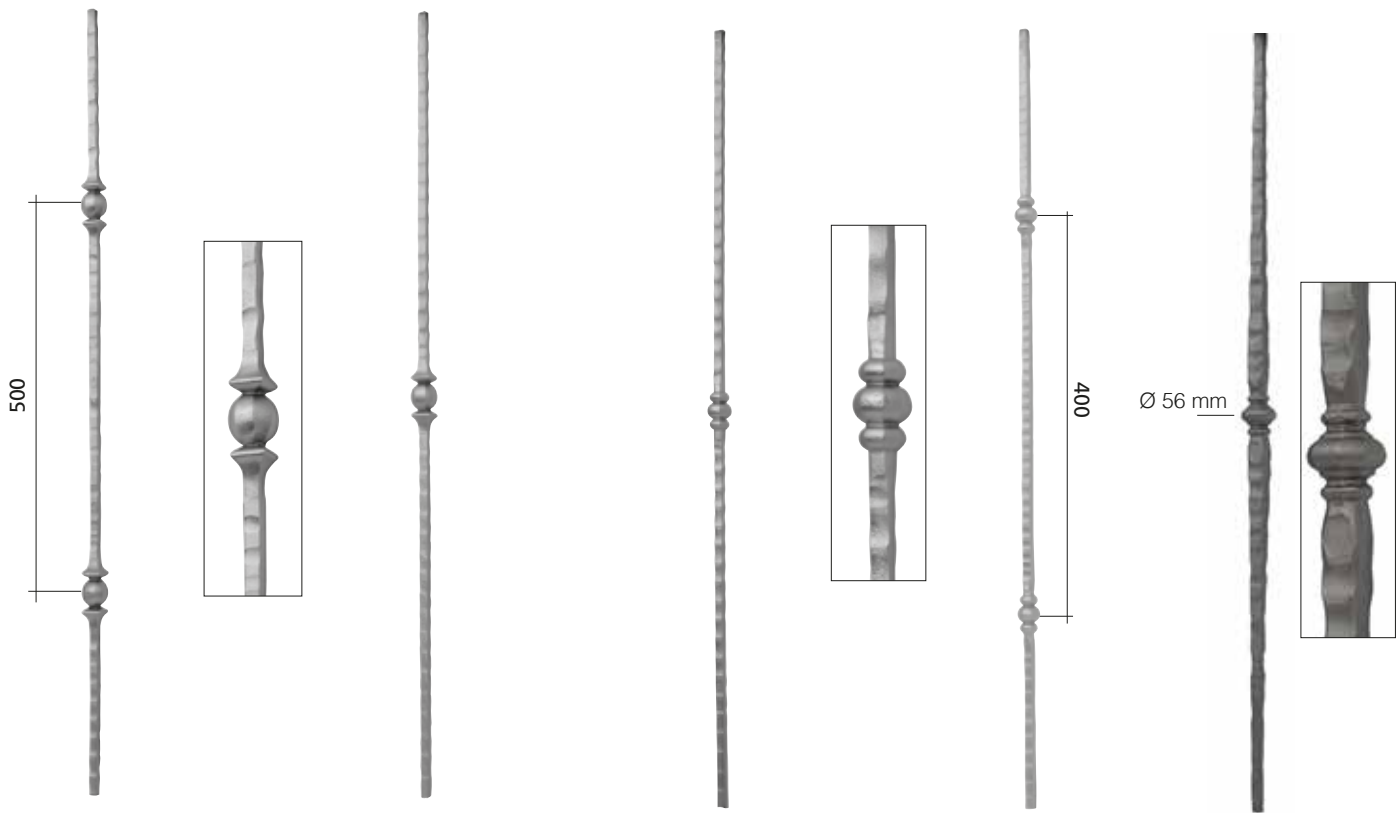

Art.	Sección	Largo	Art.	Sección	Largo	Art.	Sección	Largo	Art.	Sección	Largo	Art.	Largo
105/1/C	12 x 12 mm	1000 mm	105/2/C	12 x 12 mm	1000 mm	99/1/C	12 x 12 mm	1000 mm	99/2/C	12 x 12 mm	1000 mm	98/1	1000 mm





Ø 55 mm



Art.	Sección	Largo
112/10	Ø 30 x 30 mm	1200 mm

Art.	Sección	Largo
112/11	Ø 30 x 30 mm	1200 mm

Art.	Sección	Largo
112/7	Ø 25 x 25 mm	1200 mm

Art.	Sección	Largo
112/9	Ø 30 x 30 mm	1200 mm



Ø 55 mm

Art.	Sección	Largo
112/5	Ø 25 x 25 mm	1200 mm
112/6	Ø 30 x 30 mm	1200 mm





Art.	Sección	Largo
497/1/C	Ø 12 mm	1000 mm



Art.	Sección	Largo
497/2/C	Ø 12 mm	1000 mm



Art.	Sección	Largo
499/2/C	Ø 12 mm	1000 mm



Art.	Sección	Largo
499/1/C	Ø 12 mm	1000 mm





Art.	Sección	Largo
508/3/C	Ø 14 mm	1000 mm



Art.	Sección	Largo
508/4/C	Ø 14 mm	1000 mm



Art.	Sección	Largo
505/3	Ø 14 x 14 mm	1000 mm



Art.	Sección	Largo
505/4	Ø 14 x 14 mm	1000 mm



Art.	Sección	Largo
108/A/1	Ø 12 x 12 mm	1000 mm



Art.	Sección	Largo
108/A/2	Ø 12 x 12 mm	1000 mm



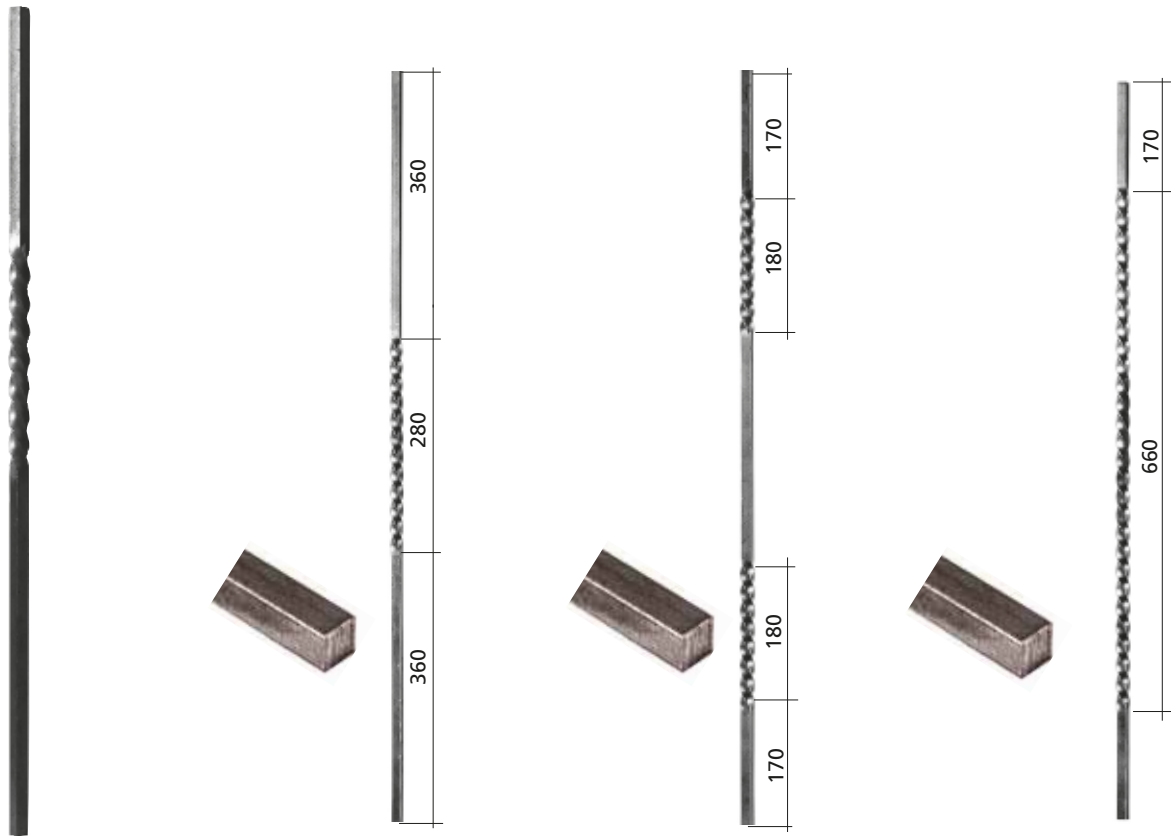

Art.	Sección	Largo
113/7	∅ 20 x 20 mm	1100 mm
113/8	∅ 30 x 30 mm	1100 mm

Art.	Sección	Largo
1148/5	∅ 12 x 12 mm	1000 mm
1148/6	∅ 14 x 14 mm	1000 mm
1148/6/S	∅ 16 x 16 mm	1000 mm

Art.	Sección	Largo
1148/8	∅ 12 x 12 mm	1000 mm
1148/9	∅ 14 x 14 mm	1000 mm
1148/9/S	∅ 16 x 16 mm	1000 mm

Art.	Sección	Largo
1148/3/S	∅ 16 x 16 mm	1000 mm







Art.	Sección	Largo
64/F/2	∅ 12 x 12 mm	900 mm
64/F/3	∅ 14 x 14 mm	900 mm



Art.	Sección	Largo
64/F/4	∅ 12 x 12 mm	900 mm
64/F/5	∅ 14 x 14 mm	900 mm



Art.	Sección	Largo
578/15	∅ 14 mm	900 mm



Art.	Sección	Largo
64/G/1	∅ 12 x 12 mm	225 x 900 mm
64/G/2	∅ 14 x 14 mm	225 x 900 mm



Art.	Sección	Largo
64/F/1	∅ 25 x 25 mm	1200 mm



Art.	Sección	Largo
801/5	∅ 25 mm	1200 mm





Art.	Sección	Largo
64/F/6	12 x 12 mm	140 x 900 mm
64/F/7	14 x 14 mm	140 x 900 mm



Art.	Sección	Largo
562/1	12 x 12 mm	900 mm
562/2	14 x 14 mm	900 mm



Art.	Sección	Largo
64/H/9	12 x 12 mm	30 x 900 mm
64/H/10	14 x 14 mm	30 x 900 mm



Art.	Sección	Largo
576/2	Ø 14 mm	900 mm



Art.	Sección	Largo
576/4	Ø 14 mm	900 mm



Art.	Sección	Largo
64/F/8	12 x 12 mm	110 x 900 mm
64/F/9	14 x 14 mm	110 x 900 mm



# BARROTES



Art.	Sección	Largo
1167/1	Ø 12 mm	1000 mm

Art.	Sección	Largo
1167/2	Ø 12 mm	1000 mm

Art.	Sección	Largo
1167/3	Ø 12 mm	1000 mm

Art.	Sección	Largo
1167/4	Ø 12 mm	1000 mm



Art.	Sección	Largo
1054/4	Ø 12 mm	110 x 1000 mm





Art.	Sección	Largo
802/2	25 x 12 mm	270 x 650 mm



Art.	Sección	Largo
802/1	30 x 30 mm	350 x 1000 mm



Art.	Sección	Largo
541/2	Ø 14 mm	340 x 900 mm



Art.	Sección	Largo
541/2	Ø 14 mm	340 x 900 mm



# BARROTES



Art.	Sección	Largo
1177/7	Ø14 mm	40 x 1000 mm

Art.	Sección	Largo
1177/8	Ø14 mm	40 x 1000 mm

Art.	Sección	Largo
64/L/3	Ø 14 mm	900 mm

Art.	Sección	Largo
64/L/4	Ø 14 mm	900 mm



Art.	Sección	Largo
134/4	14 x 14 mm	1000 mm

Art.	Sección	Largo
134/12	14 x 14 mm	1000 mm



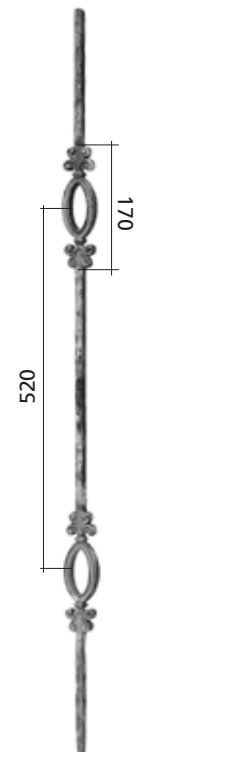
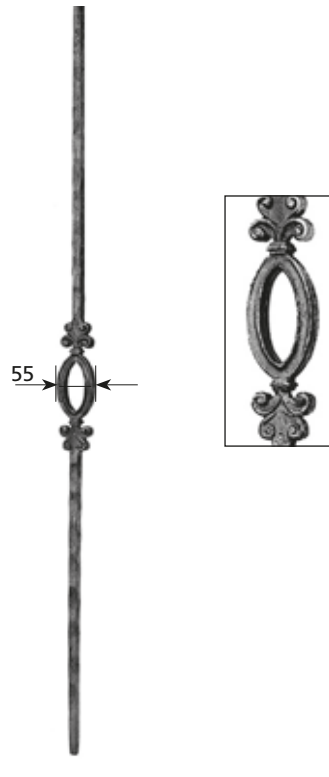
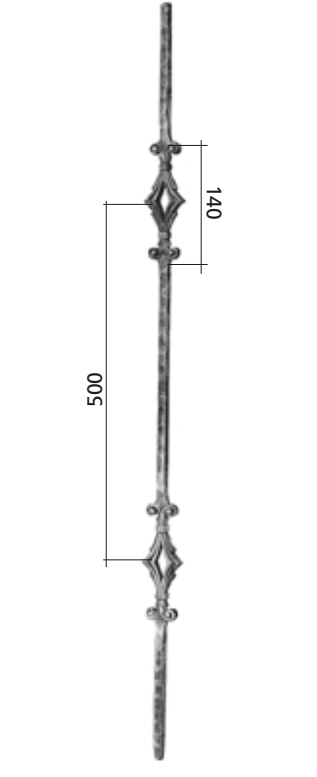
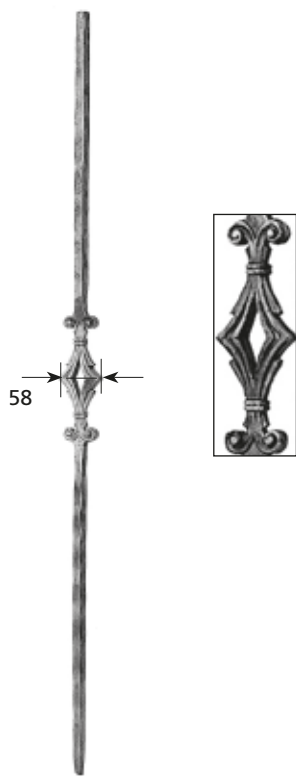

Art.	Sección	Largo
489/2	14 x 14 mm	1000 mm

Art.	Sección	Largo
489/1	14 x 14 mm	1000 mm

Art.	Sección	Largo
490/2	14 x 14 mm	1000 mm

Art.	Sección	Largo
490/1	14 x 14 mm	1000 mm

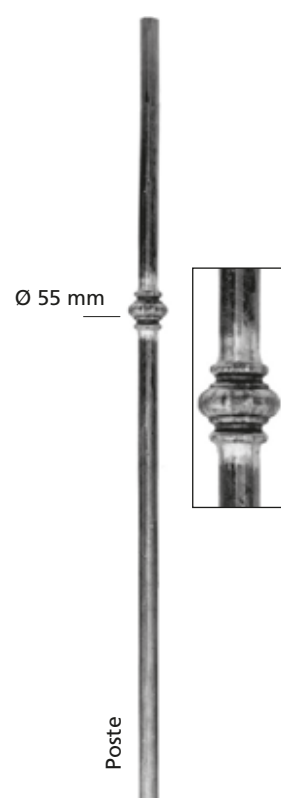

Art.	Sección	Largo
797/5	25 mm	1200 mm
797/1	30 mm	1200 mm

Art.	Sección	Largo
797/2	30 mm	1200 mm

Art.	Sección	Largo
112/8	30 x 30 mm	1200 mm





Art.	Sección	Largo
50/5	12 x 12 mm	30 x 900 mm
50/9	14 x 14 mm	30 x 900 mm



Art.	Sección	Largo
50/6	12 x 12 mm	30 x 900 mm
50/10	14 x 14 mm	30 x 900 mm



Art.	Sección	Largo
50/7	12 x 12 mm	140 x 900 mm
50/11	14 x 14 mm	140 x 900 mm



Art.	Sección	Largo
50/8	12 x 12 mm	140 x 900 mm
50/12	14 x 14 mm	140 x 900 mm



Art.	Sección	Largo
70/D/1	14 x 14 mm	900 mm



Art.	Sección	Largo
113/5	20 x 20 mm	1100 mm
113/6	30 x 30 mm	1100 mm





Poste

Art.	Sección	Largo
113/3	∅ 20 x 20 mm	1100 mm
113/4	∅ 30 x 30 mm	1100 mm



Poste

Art.	Sección	Largo
113/1	∅ 20 x 20 mm	1100 mm
113/2	∅ 30 x 30 mm	1100 mm





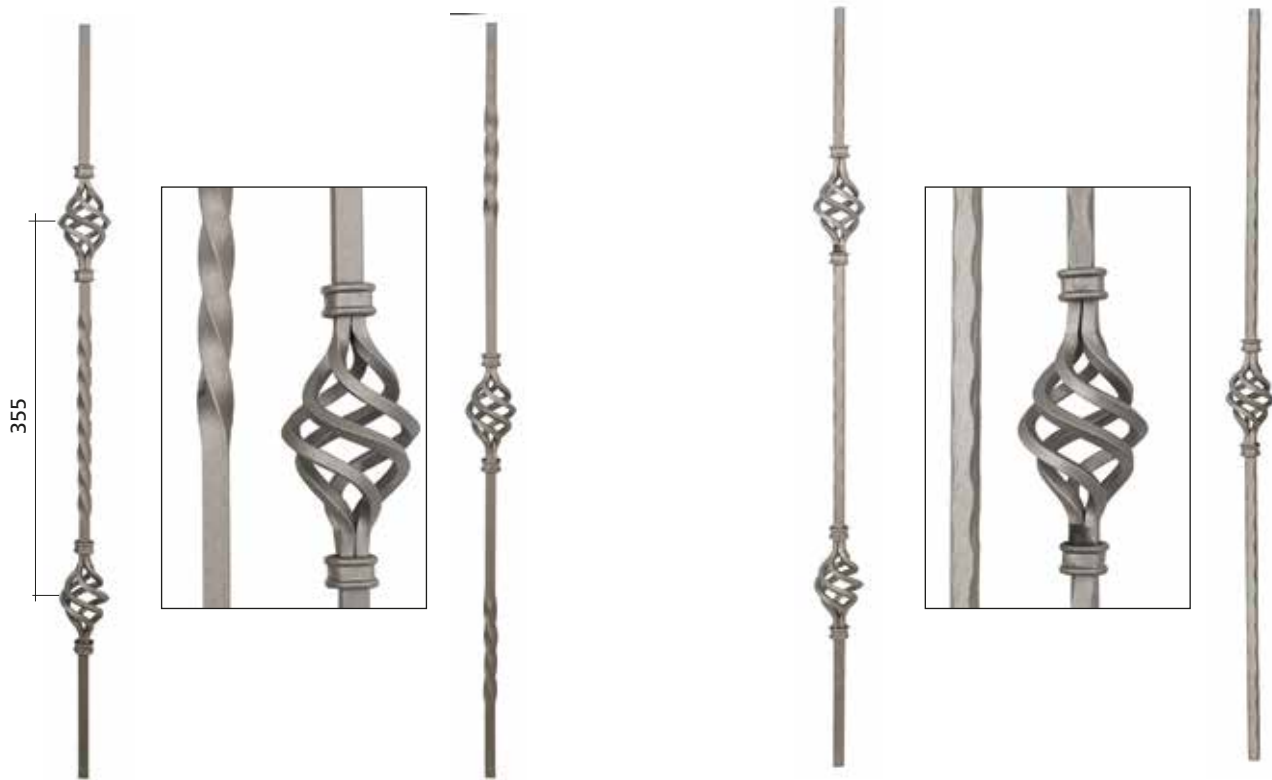

Art.	Sección	Largo
48/1	∅ 12 x 12 mm	55 x 900 mm
48/6	∅ 14 x 14 mm	55 x 900 mm

Art.	Sección	Largo
48/2	∅ 12 x 12 mm	55 x 900 mm
48/7	∅ 14 x 14 mm	55 x 900 mm

Art.	Sección	Largo
48/3	∅ 12 x 12 mm	55 x 900 mm
48/8	∅ 14 x 14 mm	55 x 900 mm

Art.	Sección	Largo
48/4	∅ 12 x 12 mm	55 x 900 mm
48/9	∅ 14 x 14 mm	55 x 900 mm



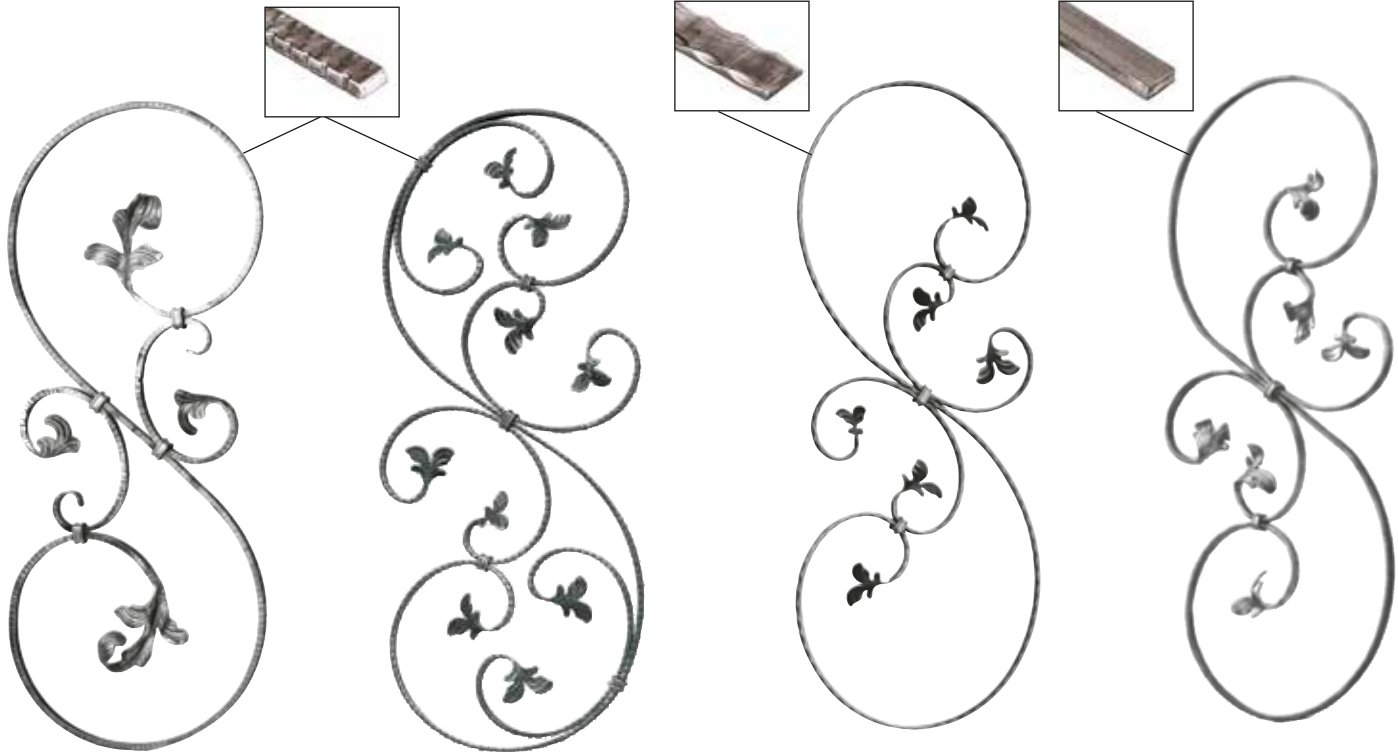

Martilleado

Art.	Sección	Largo	Art.	Sección	Largo	Art.	Sección	Largo	Art.	Sección	Largo
52/G/1	16 x 8 mm	350 x 870 mm	1671/3	12 x 6 mm	350 x 870 mm	1671/4	12 x 6 mm	350 x 870 mm	52/1	12 x 6 mm	350 x 870 mm





Art.	Sección	Largo
52/2	∅ 12 x 12 mm	235 x 900 mm



Art.	Sección	Largo
49/3	∅ 12 x 12 mm	180 x 900 mm



Art.	Sección	Largo
52/A/3	∅ 12 x 12 mm	170 x 900 mm

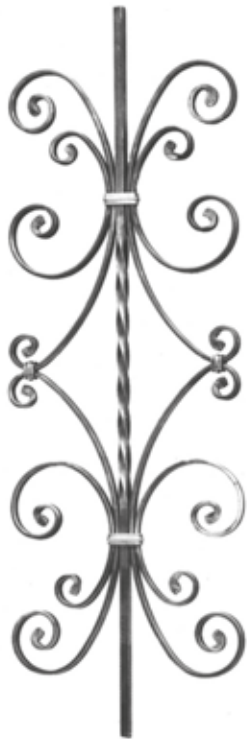

Art.	Sección	Largo
51/3	∅ 12 x 12 mm	300 x 900 mm



Art.	Sección	Largo
511/1	∅ 12 x 12 mm	125 x 900 mm



Art.	Sección	Largo
1122/1	∅ 12 x 12 mm	140 x 1000 mm



Art.	Sección	Largo
1122/3	∅ 12 x 12 mm	180 x 1000 mm





Art.	Sección	Largo
148/2	Ø 30 mm	900 mm



Art.	Sección	Largo
70/D/5	14 x 14 mm	900 mm



Art.	Sección	Largo
149/1	Ø 30 mm	900 mm



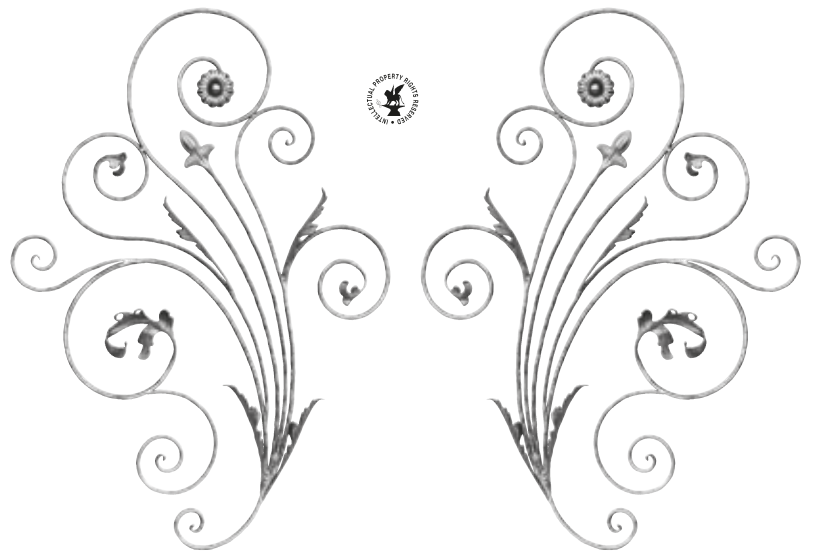
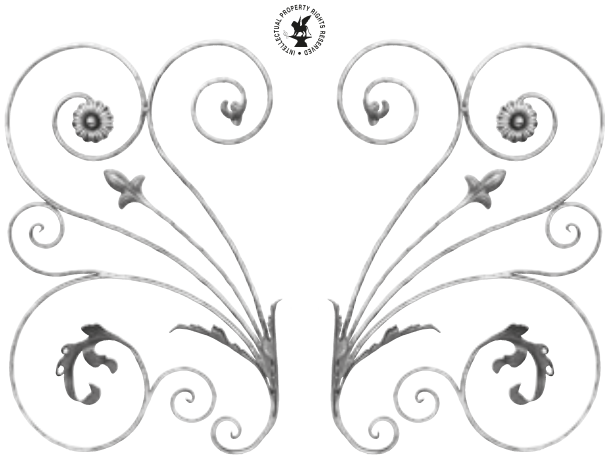

Art. 716/1  
Ø 12 mm  
Martilleado  
920 x 1280 mm

Art. 716/2  
Ø 12 mm  
Martilleado  
920 x 1280 mm

Art.	Sección	Largo
715/1	Ø 12 mm	580 x 880 mm

Art.	Sección	Largo
715/2	Ø 12 mm	580 x 880 mm

Martilleado

Art.	Sección	Largo
716/1	Ø 12 mm	920 x 1280 mm

Martilleado

Art.	Sección	Largo
716/2	Ø 12 mm	920 x 1280 mm

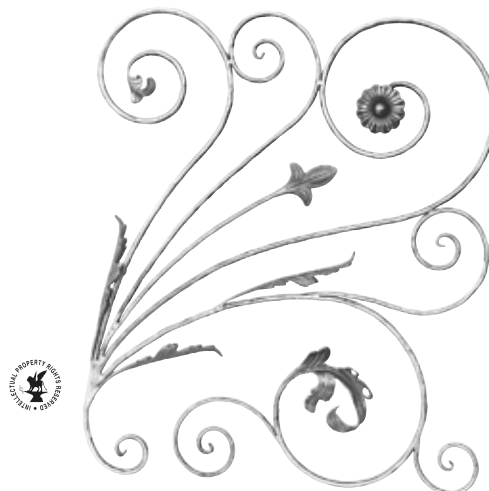
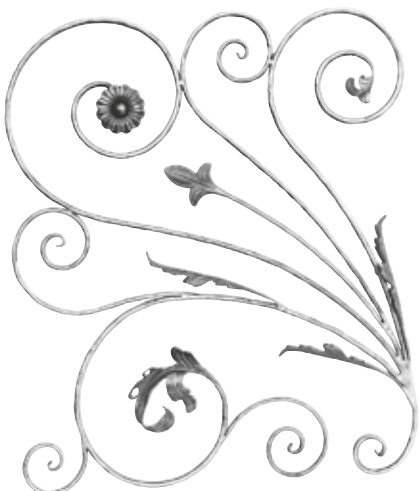

Martilleado

Art.	Sección	Largo
716/3	Ø 12 mm	760 x 890 mm

Martilleado

Art.	Sección	Largo
716/4	Ø 12 mm	760 x 890 mm

Art.	Sección	Largo
720/1	□ 14 x 14 mm	515 x 670 mm



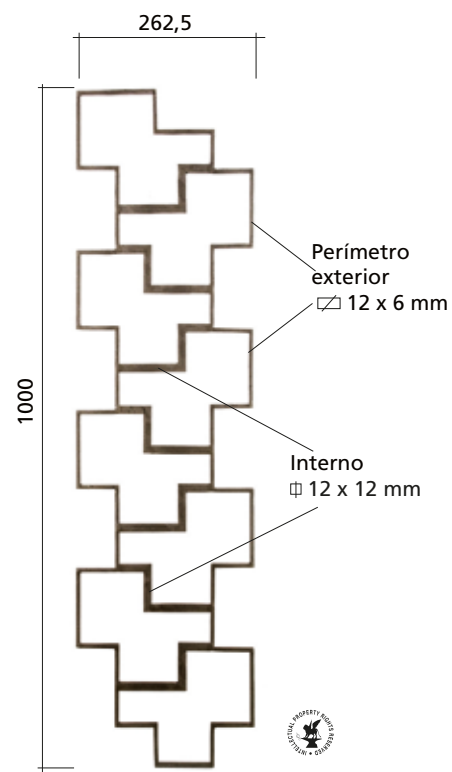

Art.	Sección	Largo
GD293/1	12 x 6 + 12 mm	1000 mm

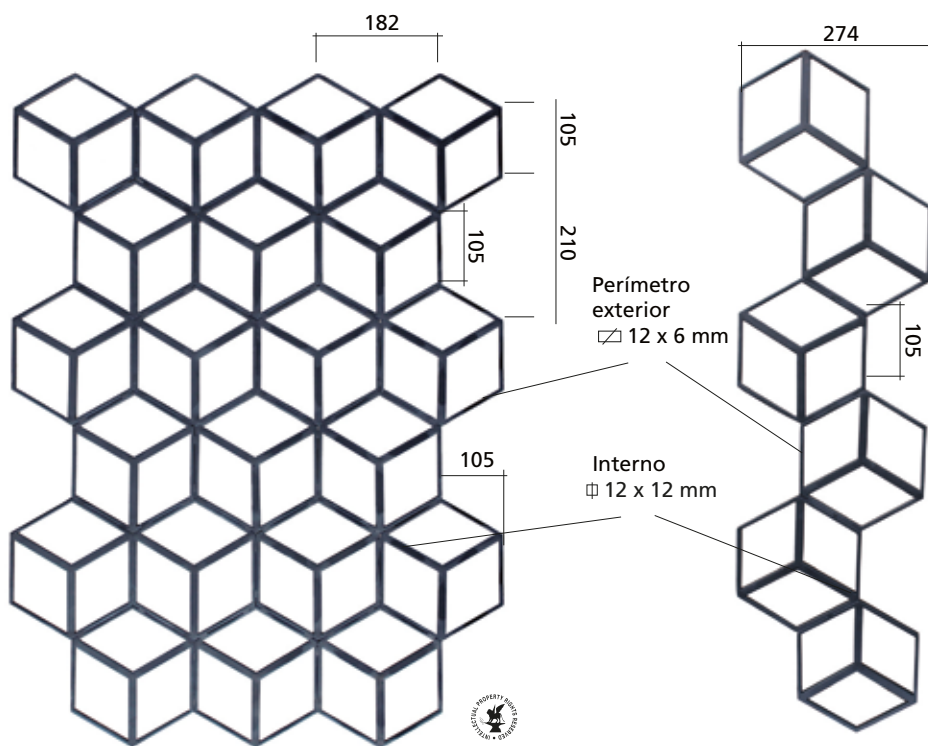

Art.	Sección	Largo
GD287/2	12 x 6 + 12 mm	274 x 1000 mm

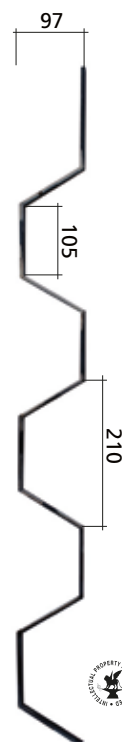

Art.	Sección	Largo
GD287/3	12 x 6 mm	97 x 1000 mm



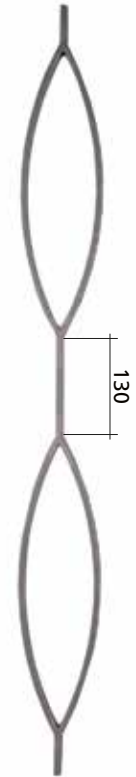
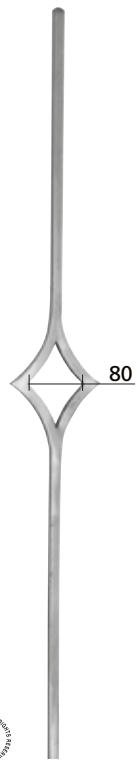
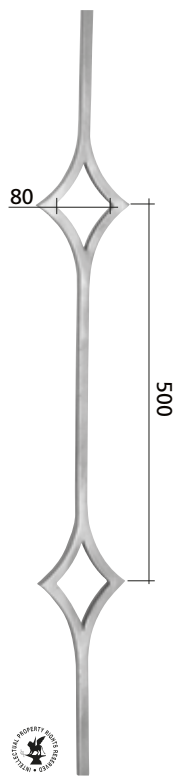

Art.	Sección	Largo	Art.	Sección	Largo	Art.	Sección	Largo	Art.	Sección	Largo
GD58/2	∅ 12 x 12 mm	120 x 1000 mm	GD58/3	∅ 12 x 12 mm	120 x 1000 mm	GD278/1	∅ 14 x 8 mm	105 x 1000 mm	GD278/2	∅ 14 x 8 mm	105 x 1000 mm



PANELES SOBREPUESTOS

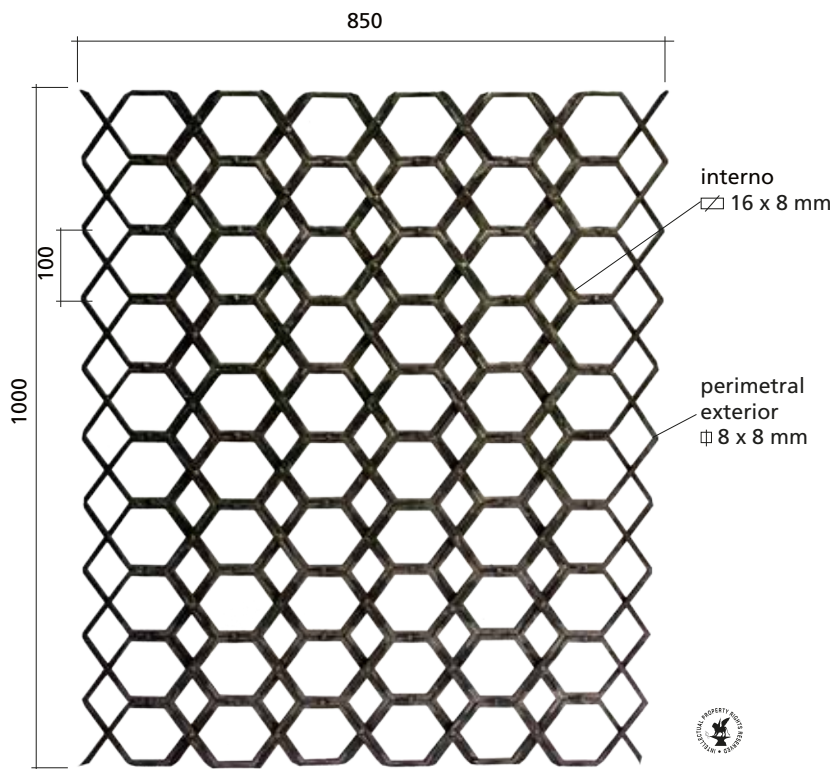

Art.	Sección	Largo
GD299/1	16 x 8 + 8 x 8 mm	850 x 1000 mm

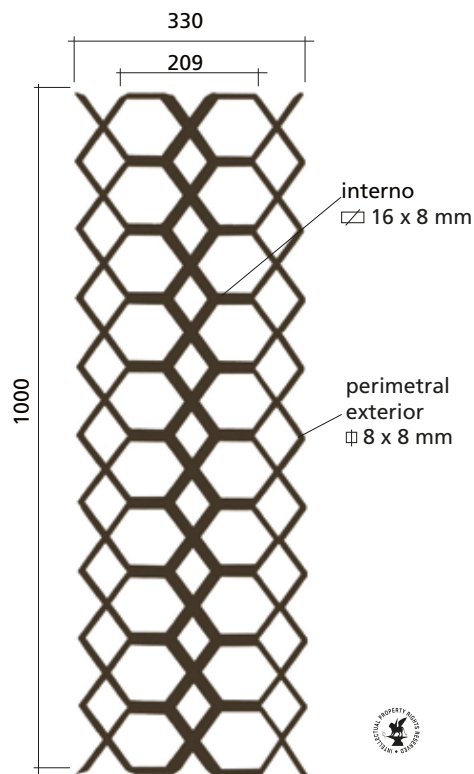

Art.	Sección	Largo
GD299/2	16 x 8 + 8 x 8 mm	330 x 1000 mm

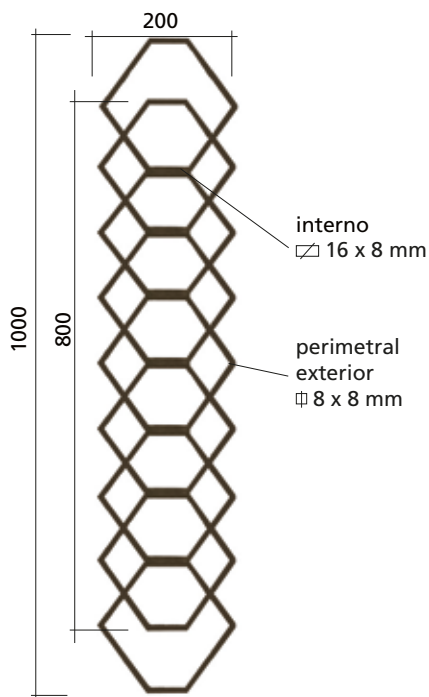

Art.	Sección	Largo
GD299/3	16 x 8 + 8 x 8 mm	200 x 1000 mm

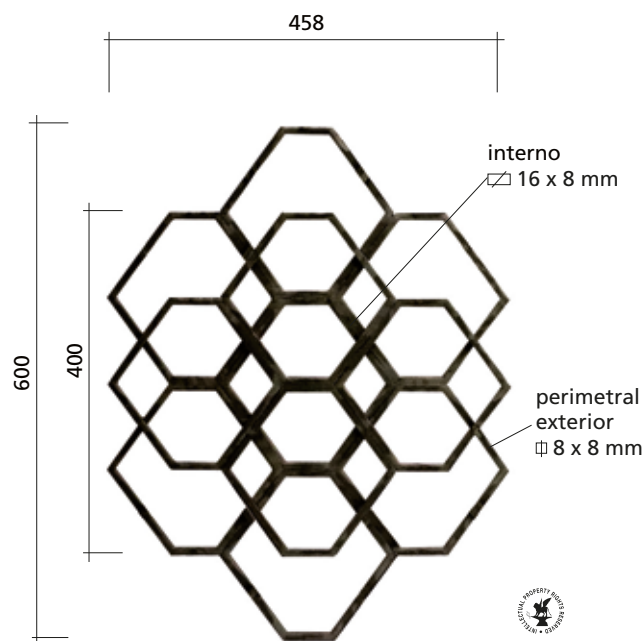

Art.	Sección	Largo
GD299/4	16 x 8 + 8 x 8 mm	458 x 660 mm





PANELES SOBREPUESTOS

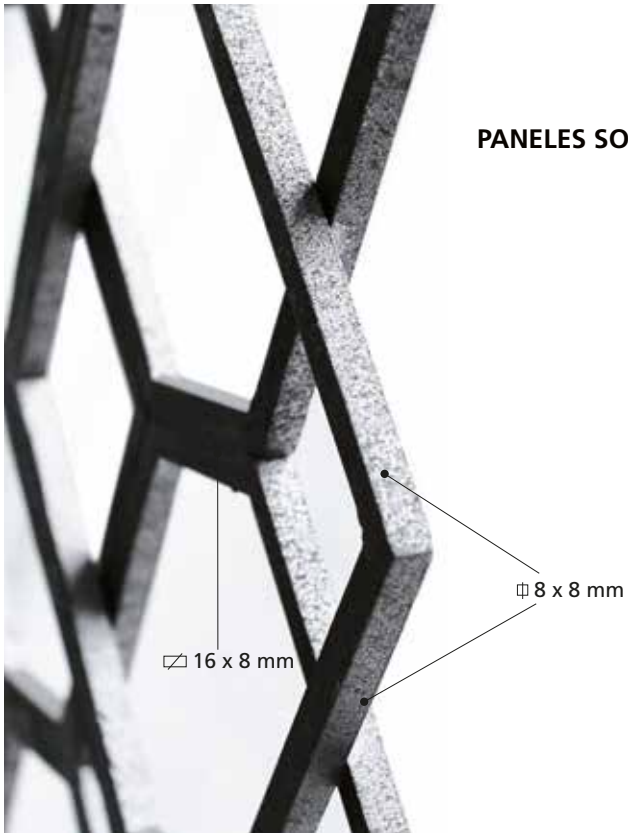

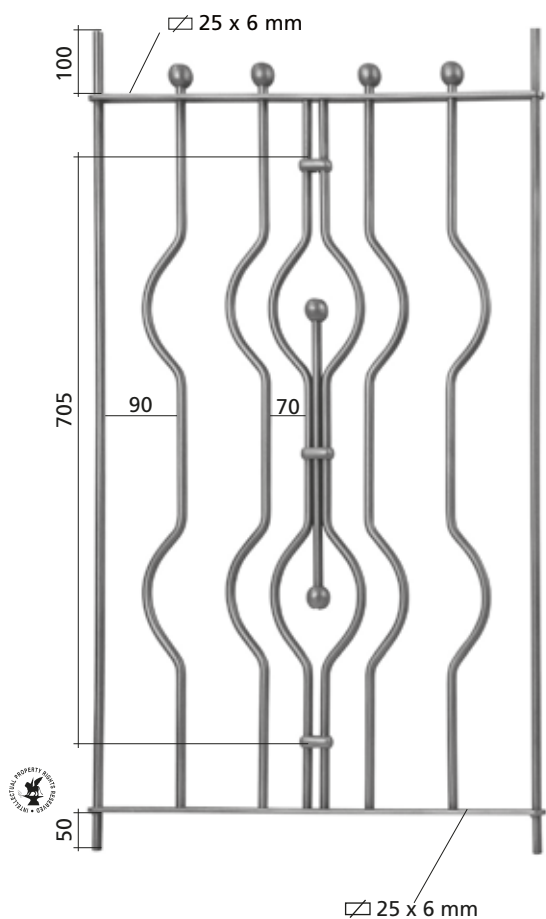

Art.	Sección	Largo
GD40/1	Ø 12 mm	620 x 1000 mm

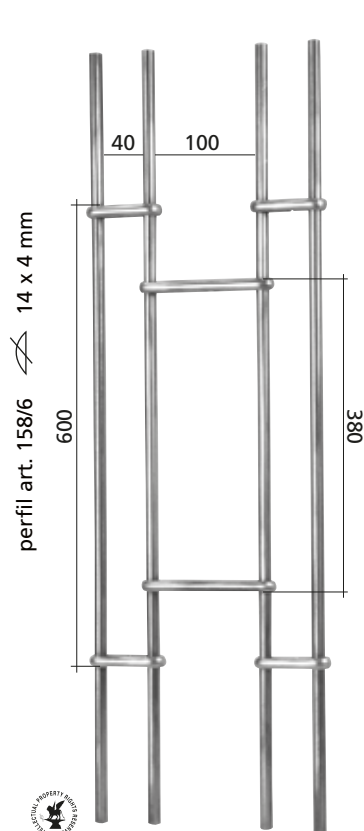

Art.	Sección	Largo
GD38/1	Ø 12 mm	230 x 1000 mm

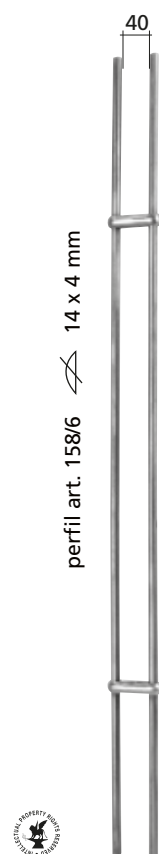

Art.	Sección	Largo
GD38/2	Ø 12 mm	65 x 1000 mm

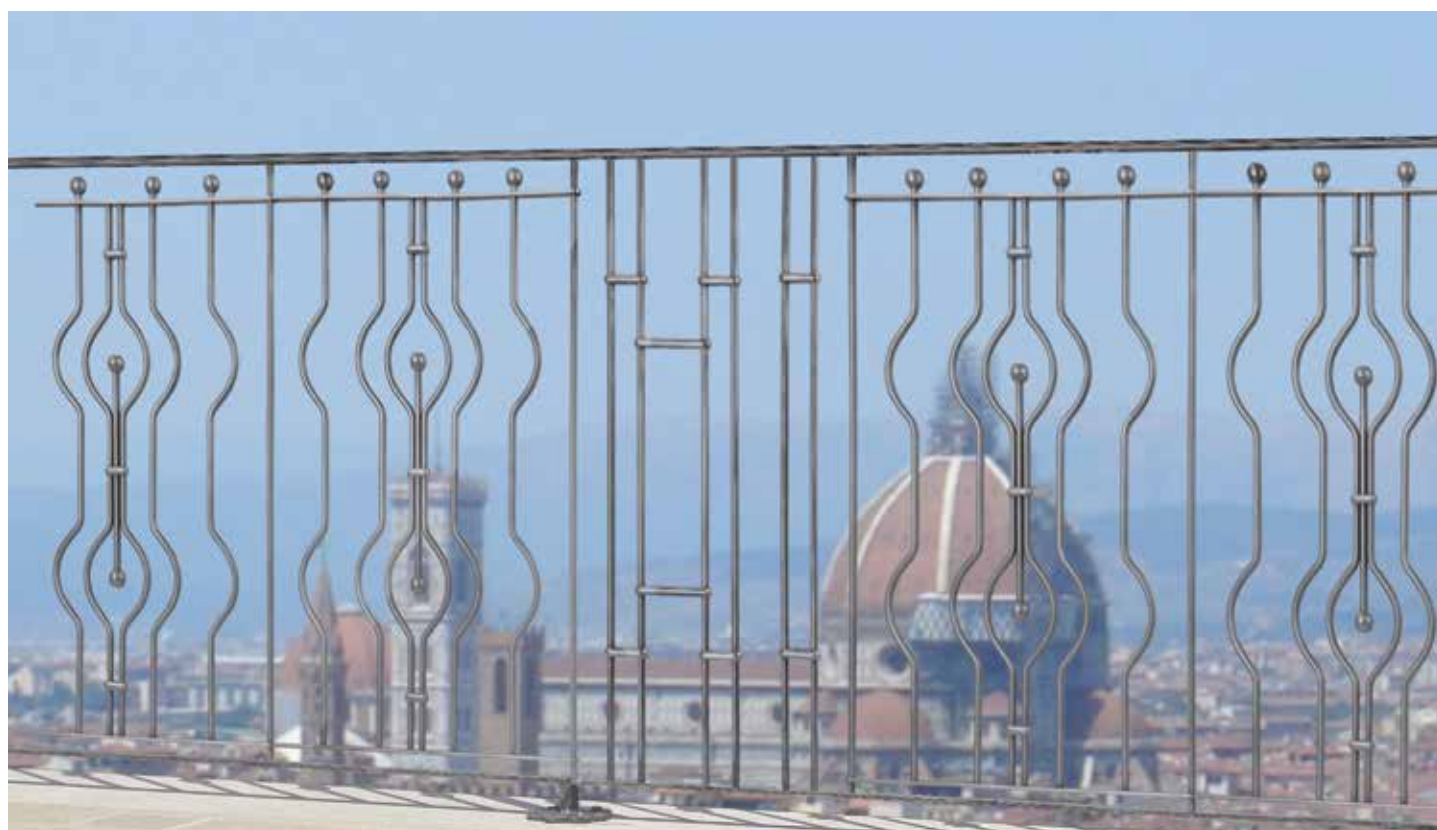



ATENCIÓN:  
teniendo en cuenta las peculiaridades del producto, sólo podrá ser **zincado a frío**. una zincadura en caliente podría comprometer la estética

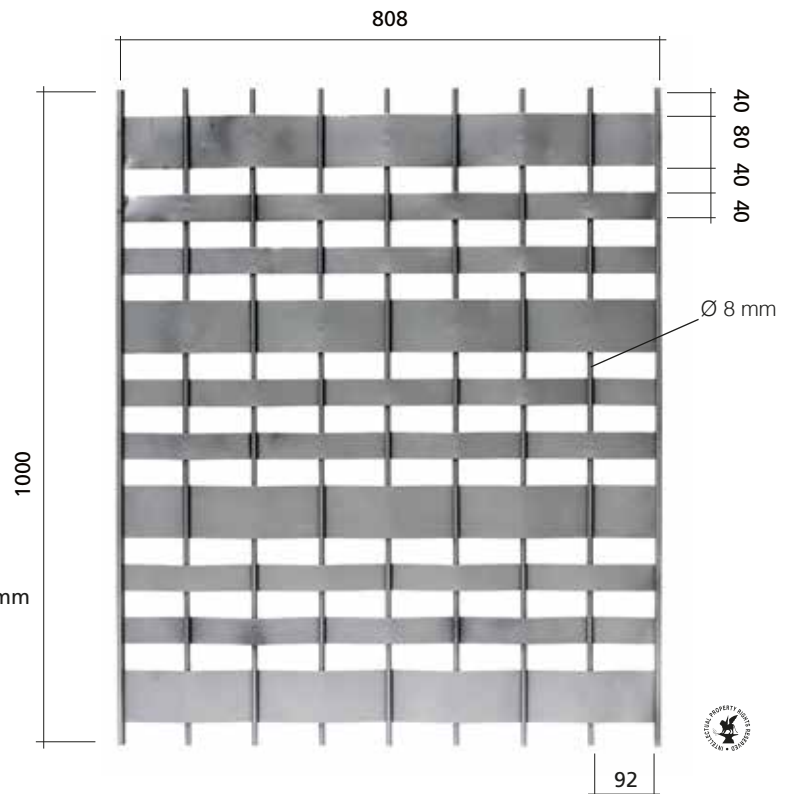
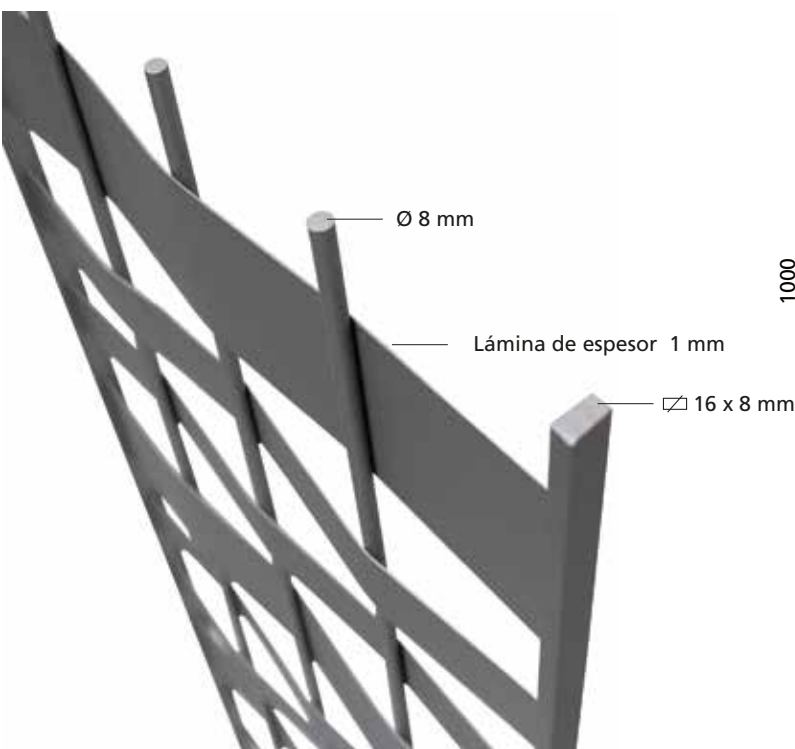

Art.	Sección	Largo
GD302/3	16 x 8 mm	808 x 1000 mm





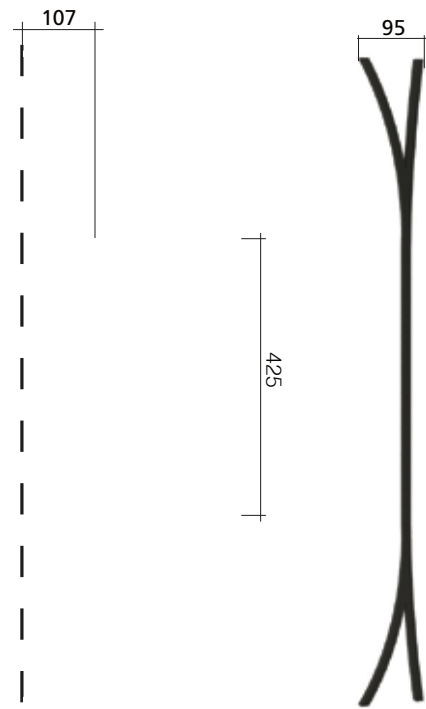

Art.	Sección	Largo
GD290/1	∅ 12 x 12 mm	1000 mm



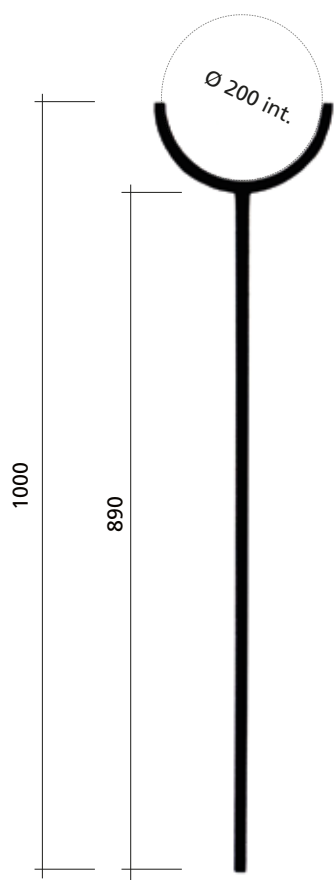

Art.	Sección	Largo
GD296/1	□ 12 x 12 mm	224 x 1000 mm

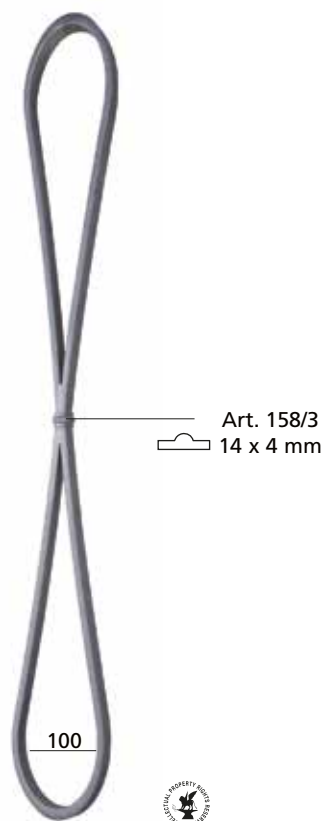

Art.	Sección	Largo
GD179/2	⊞ 14 x 8 mm	115 x 1000 mm



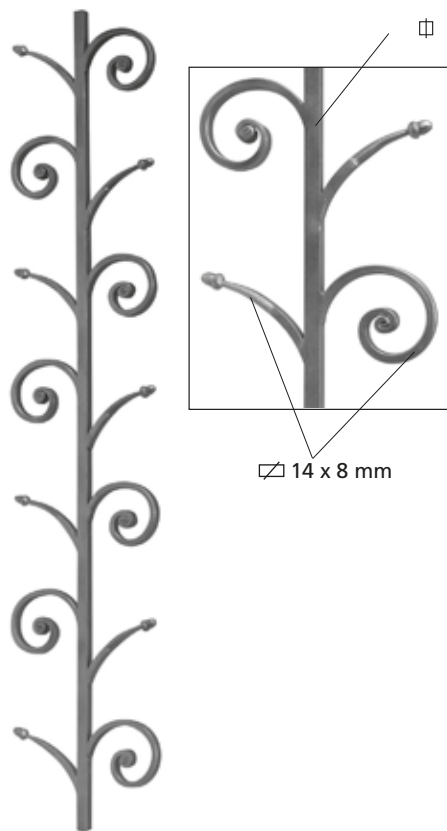

∅ 14 mm

Art.700/4/C/2

14 x 8 mm

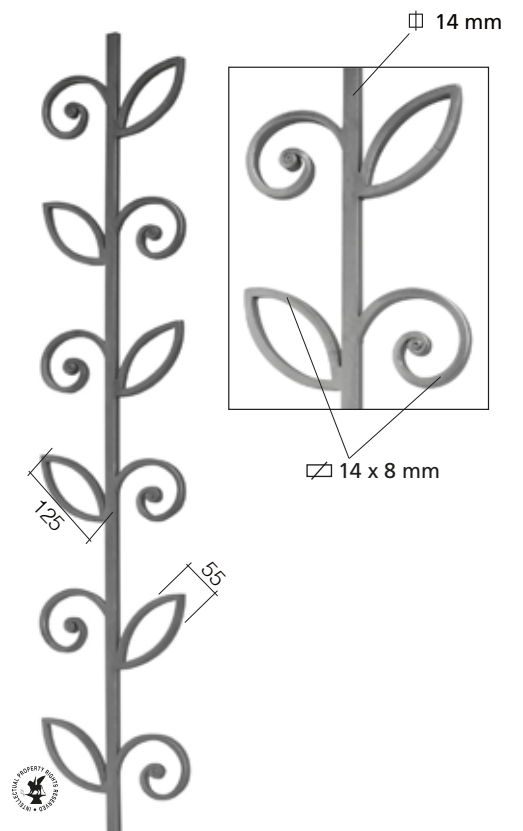

∅ 14 mm

14 x 8 mm



Art.	Sección	Largo
GD176/1	∅ 14 x 14 mm	200 x 1000 mm

Art.	Sección	Largo
GD176/2	∅ 14 x 14 mm	200 x 1000 mm

Art.	Sección	Largo
GD176/3	∅ 14 x 14 mm	200 x 1000 mm



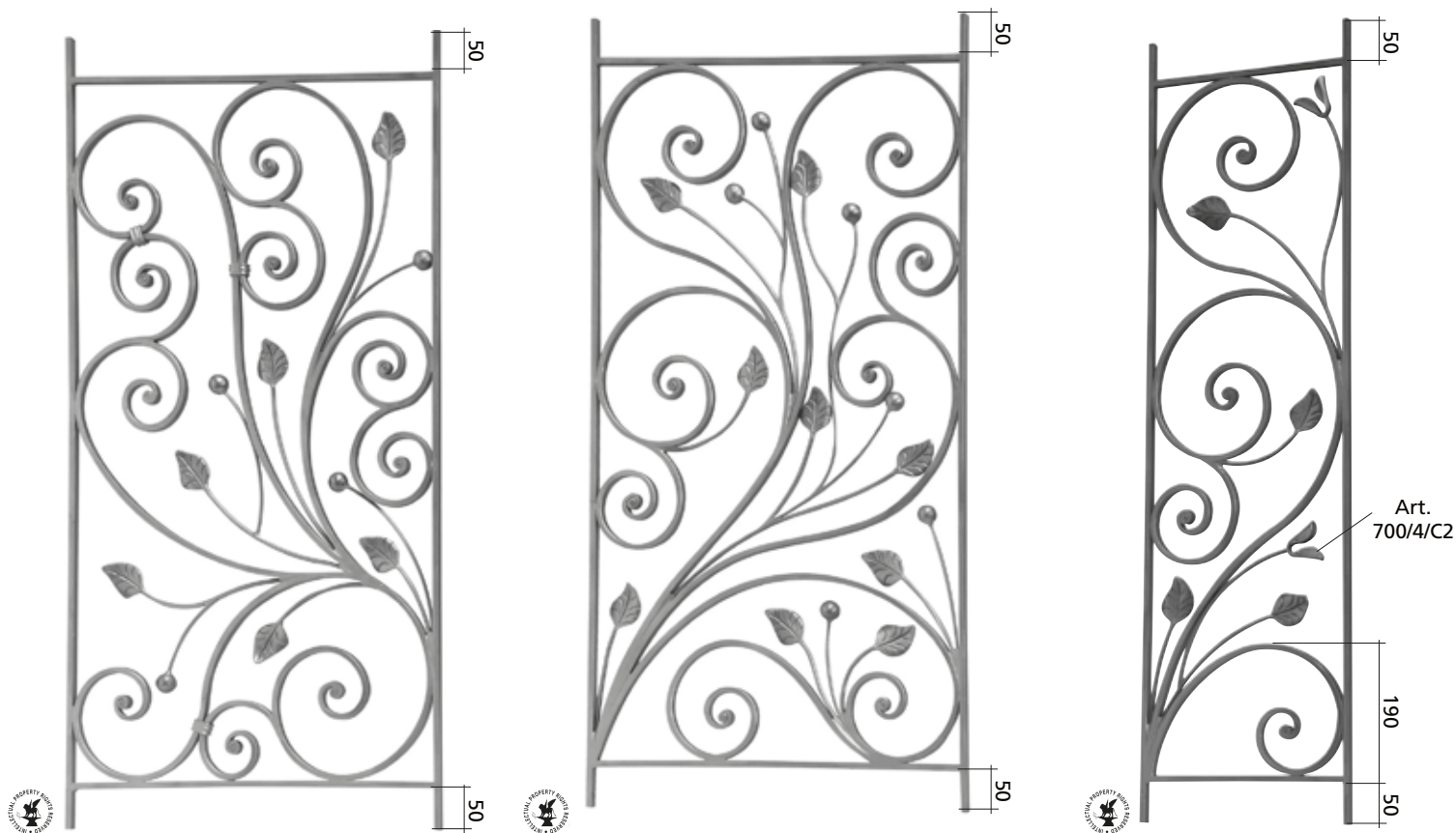

Art.	Sección	Largo
GD222/2	14 x 8 mm	500 x 1000 mm

Art.	Sección	Largo
GD222/1	14 x 8 mm	500 x 1000 mm

Art.	Sección	Largo
GD223/1	14 x 8 mm	275 x 1000 mm





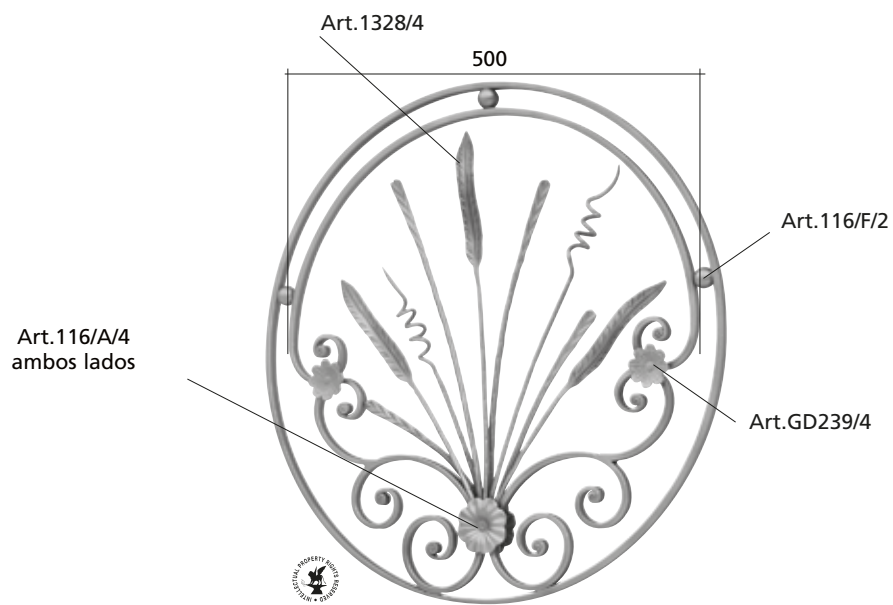

Art.	Sección	Dimensiones
GD268/2	14 x 8 mm	Ø 620 mm



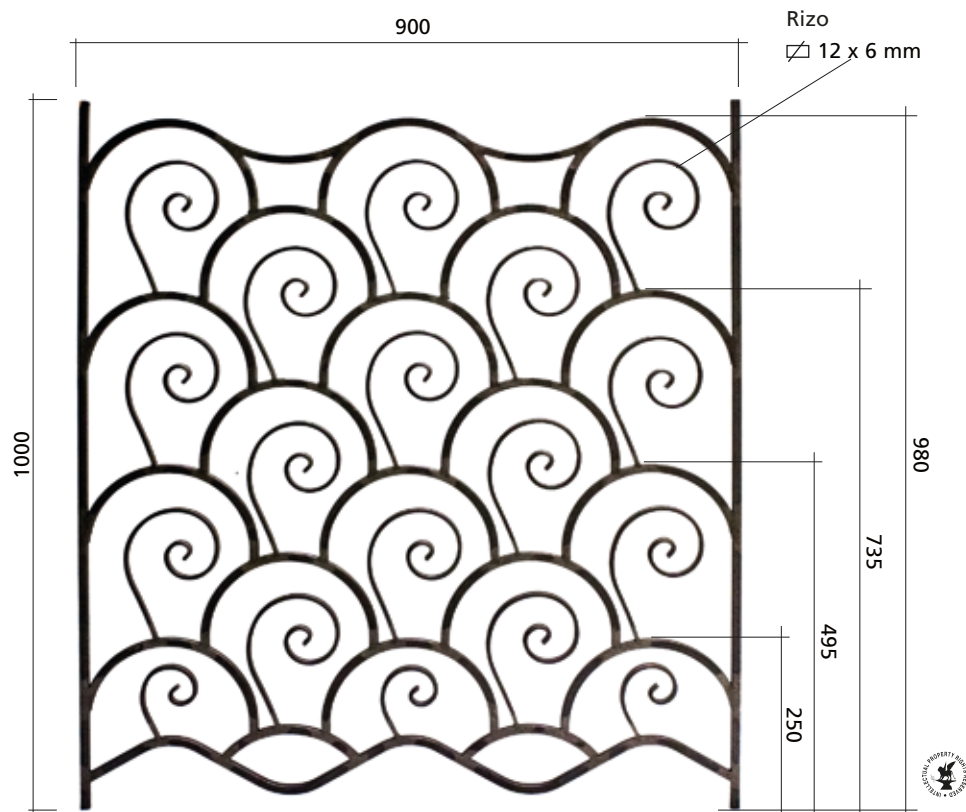

Art.	Sección	Largo
GD291/2	∅ 12 + 12 x 6 mm	900 x 1000 mm



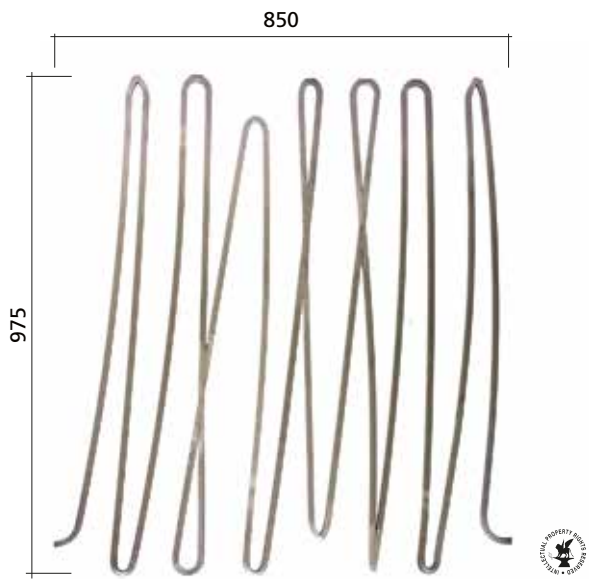

Art.	Sección	Largo
GD300/1	∅ 12 x 12 mm	L 975 x H 850 mm

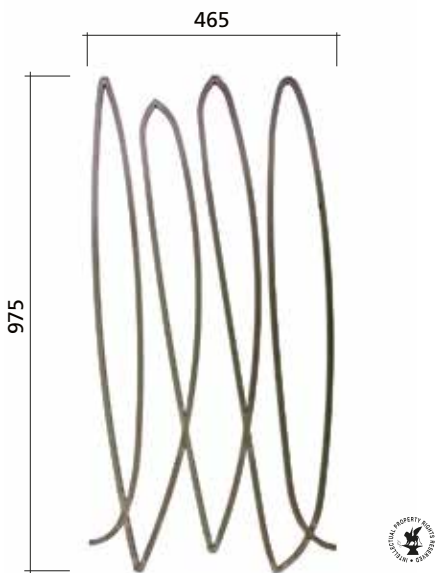

Art.	Sección	Largo
GD300/3	∅ 12 x 12 mm	L 975 x H 465 mm

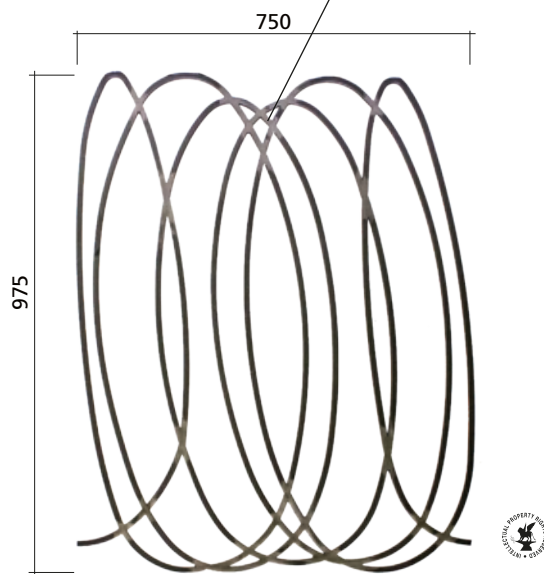

Art.	Sección	Largo
GD300/2	∅ 12 x 12 mm	L 975 x H 760 mm

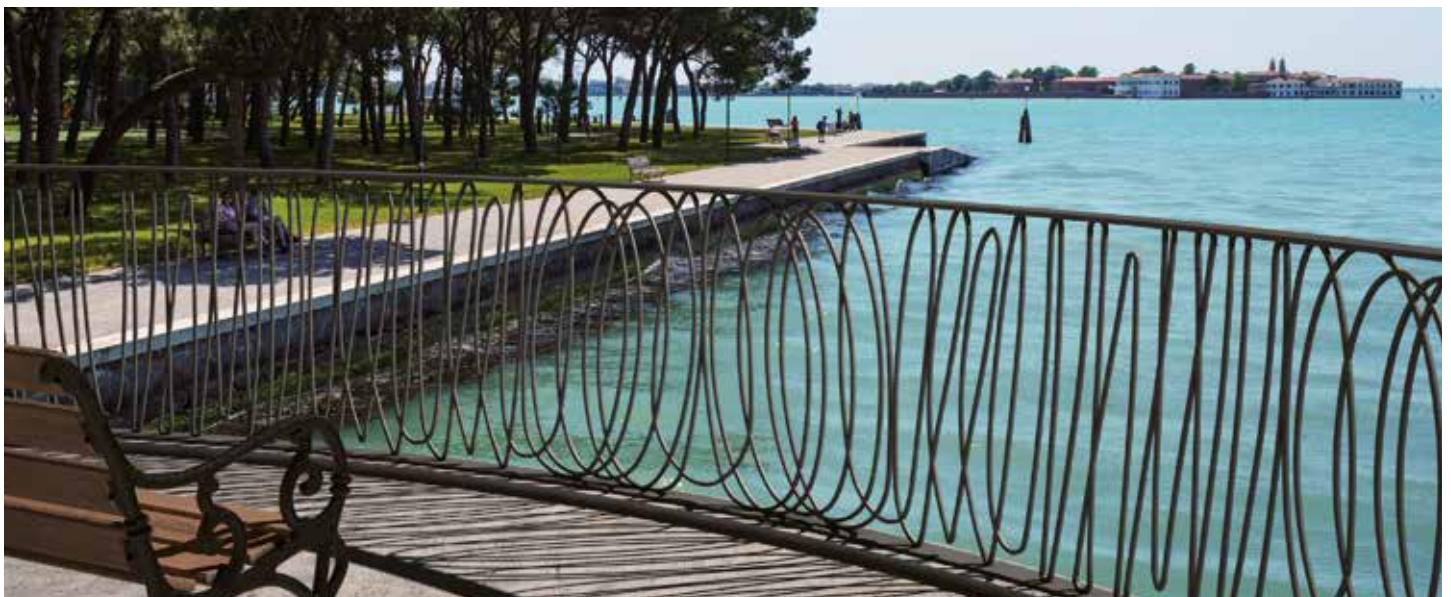

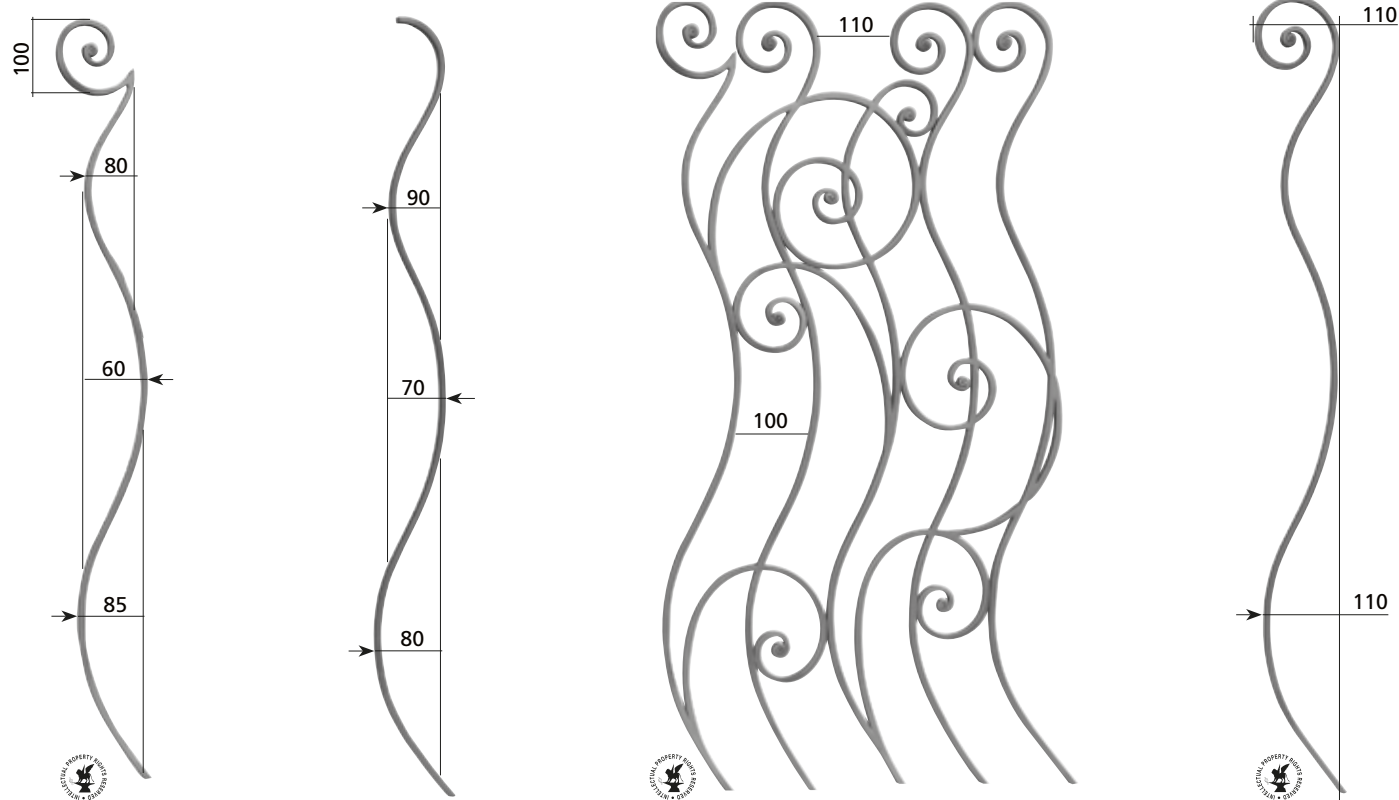

Art.	Sección	Largo	Art.	Sección	Largo	Art.	Sección	Largo	Art.	Sección	Largo
GD226/1	14 x 8 mm	110 x 1000 mm	GD226/2	14 x 8 mm	100 x 1000 mm	GD226/3	14 x 8 mm	535 x 1000 mm	GD226/4	14 x 8 mm	110 x 1000 mm



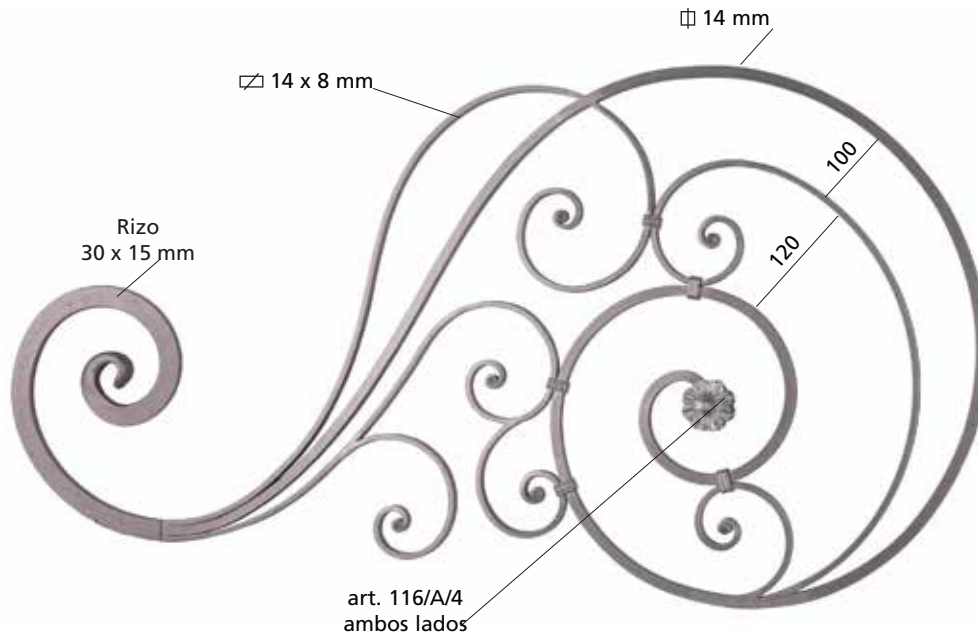

Art.	Sección	Largo
GD285/2	∅ 14 + ▭ 14 x 8 mm	700 x 1360 mm



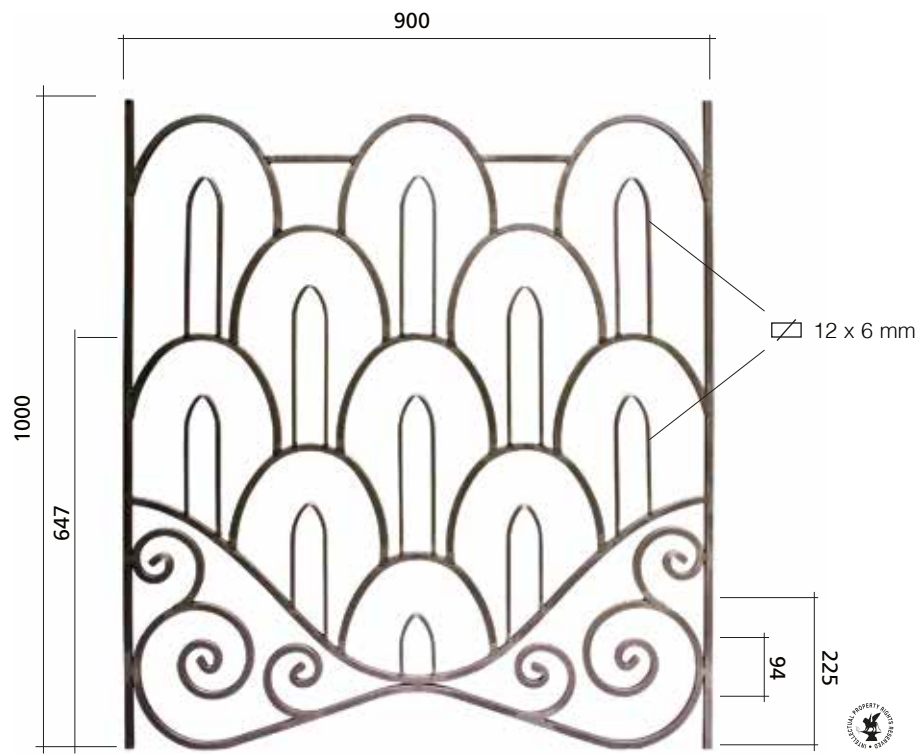

Art.	Sección	Largo
GD291/1	∅ 12 + 12 x 6 mm	900 x 1000 mm





Estructura - Marco del tubo  $\varnothing$  25 x 25 mm - Inserta  $\varnothing$  12 x 12 mm

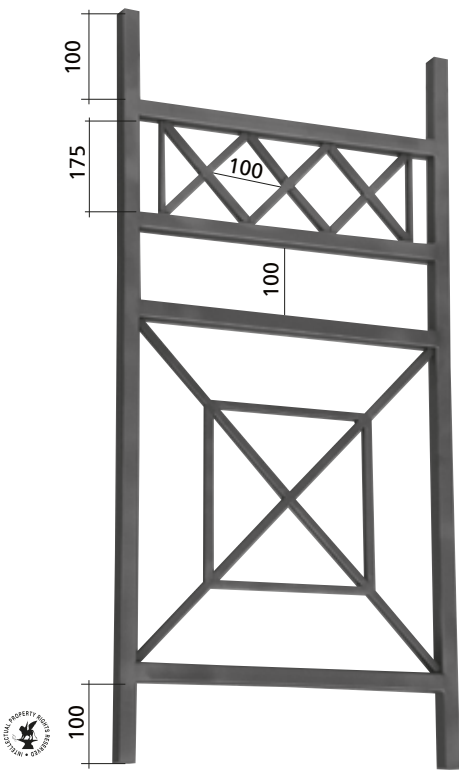

Art.	Largo
GD76/1	500 x 1000 mm

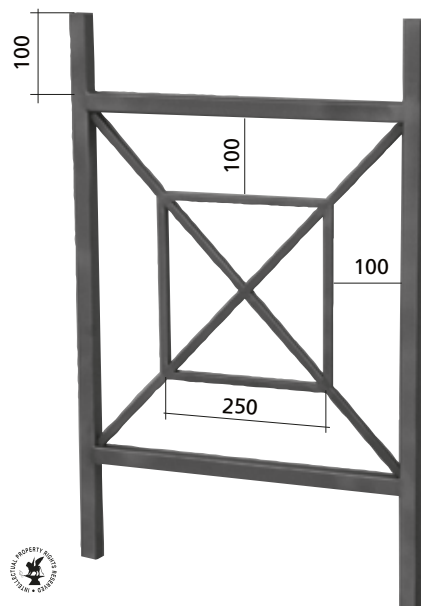

Art.	Largo
GD76/2	500 x 700 mm



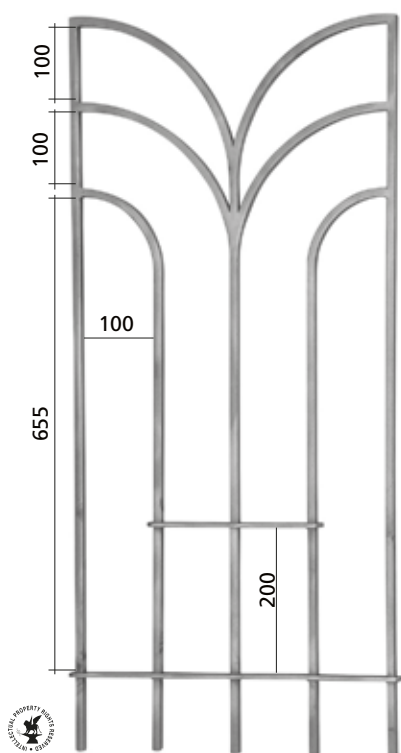

Art.	Sección	Largo
GD68/1	□ 12 x 12 mm	480 x 1000 mm

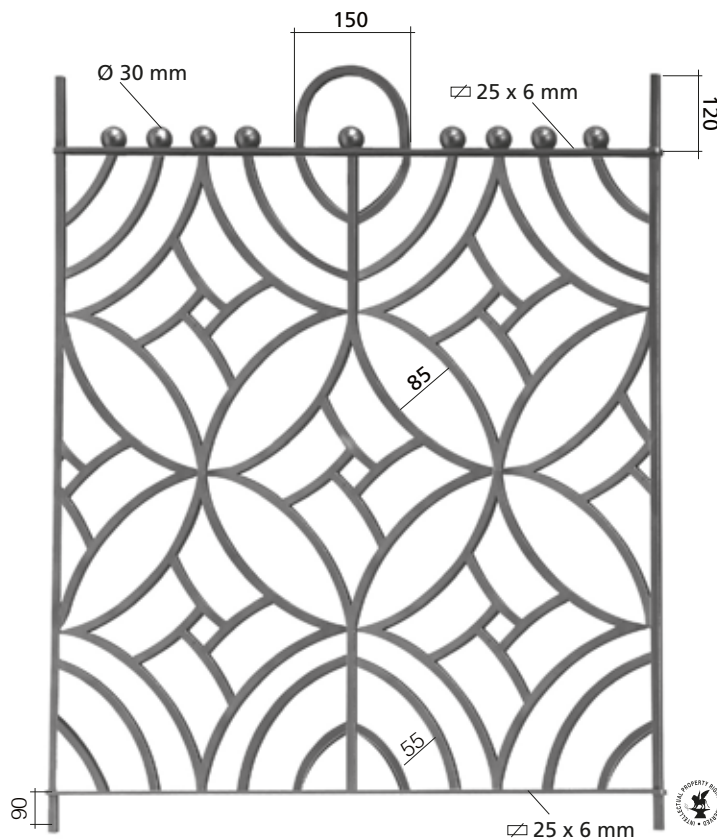

Art.	Sección	Largo
GD211/1	□ 12 x 12 mm	830 x 1000 mm

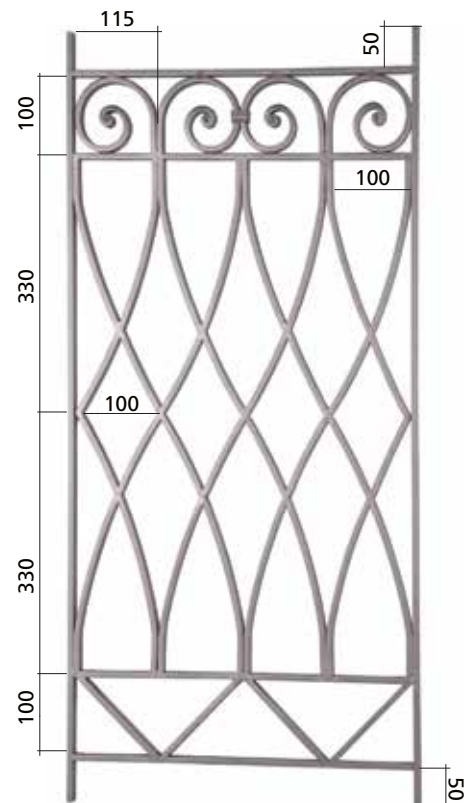

Art.	Sección	Largo
GD283/1	□ 14 x 8 mm	480 x 1000 mm





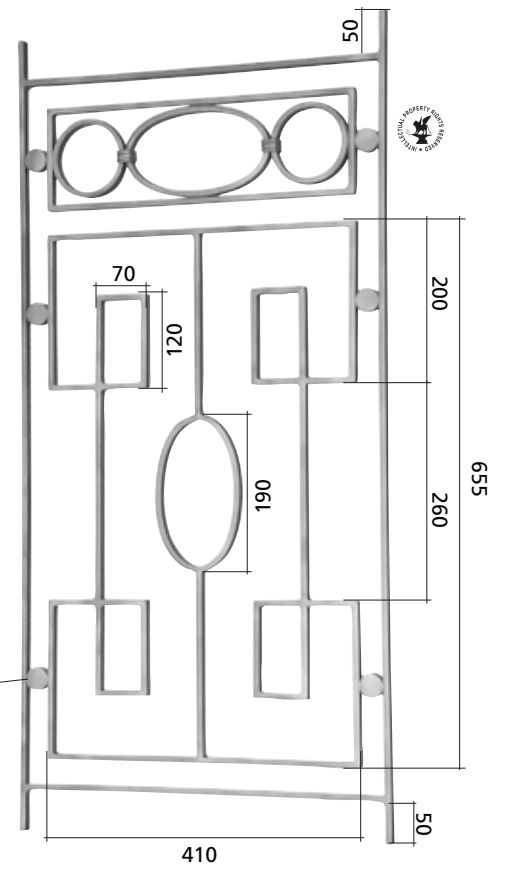
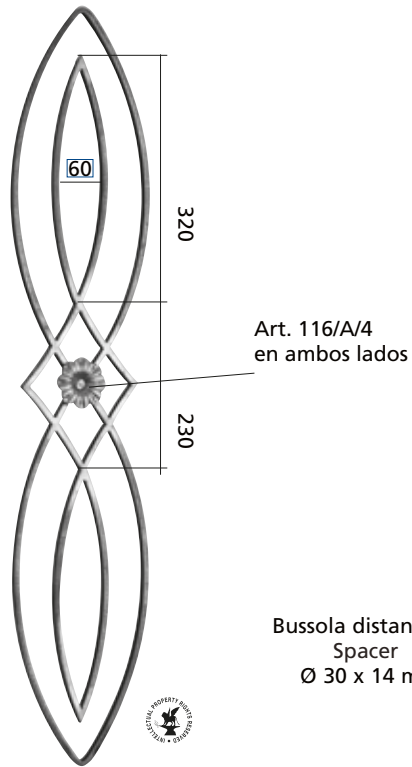
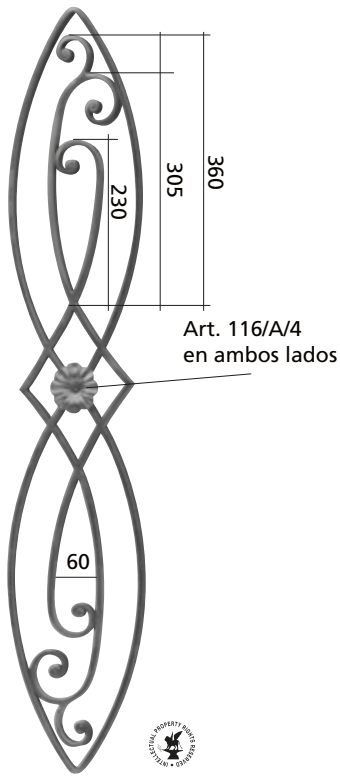

Art.	Sección	Largo
1681/1	14 x 8 mm	190 x 1000 mm

Art.	Sección	Largo
1680/2	14 x 8 mm	190 x 1000 mm

Art.	Sección	Largo
GD205/1	14 x 8 mm	495 x 1000 mm



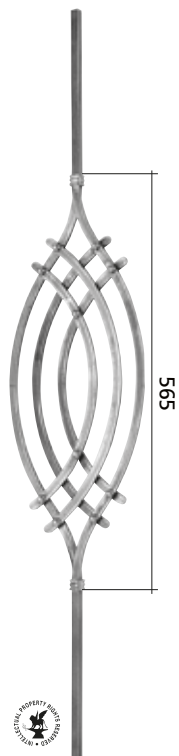

Art.	Sección	Largo
GD20/4	∅ 12 x 12 mm	200 x 1000 mm

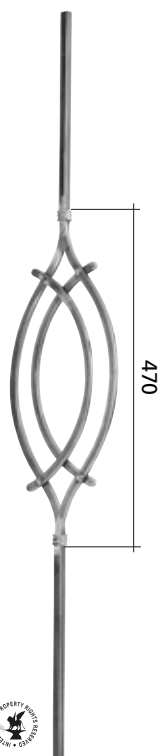

Art.	Sección	Largo
GD20/5	∅ 12 x 12 mm	180 x 1000 mm

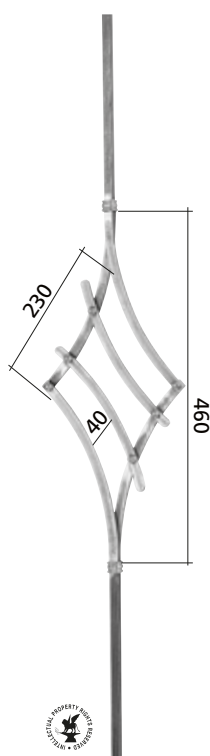

Art.	Sección	Largo
GD20/8	∅ 12 x 12 mm	200 x 1000 mm

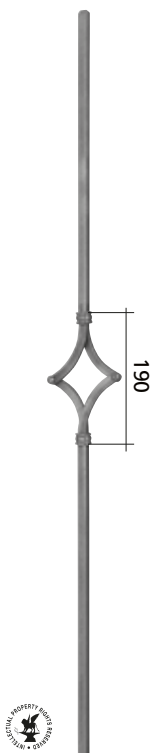
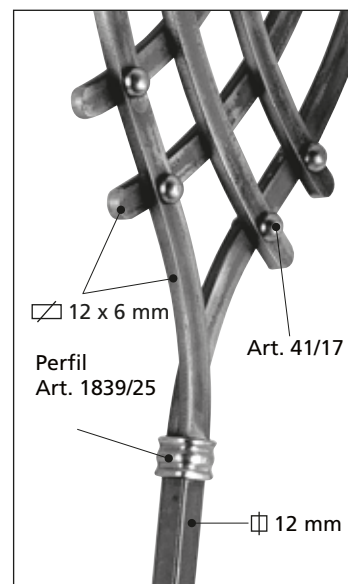

Art.	Sección	Largo
GD20/1	∅ 12 x 12 mm	110 x 1000 mm

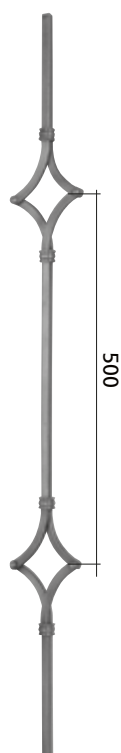

Art.	Sección	Largo
GD20/2	∅ 12 x 12 mm	110 x 1000 mm



Art.	Sección	Largo
GD16/2	∅ 14 x 8 mm	160 x 1000 mm



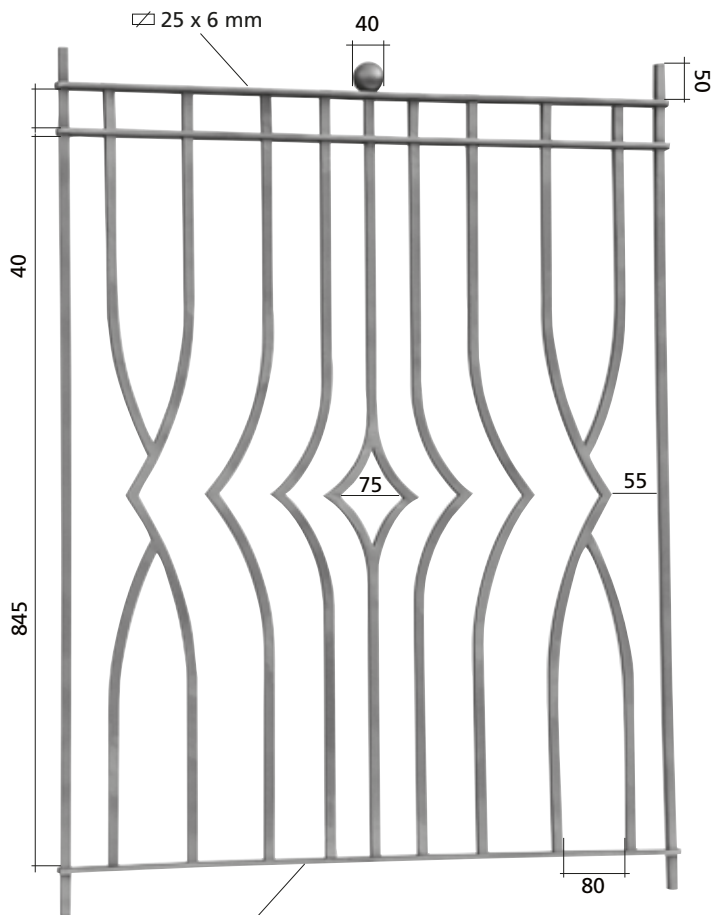

Art.	Sección	Largo
GD232/1	Φ 12 x 12 mm	760 x 1000 mm

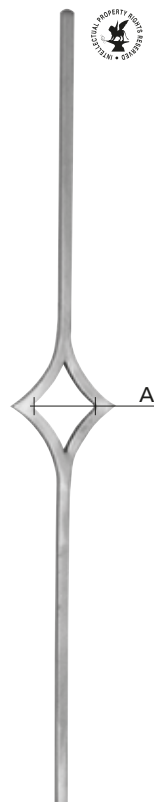

Art.	Sección	Largo	A
GD23/1	Φ 14 x 14 mm	120 x 1000 mm	75 mm
GD58/3	Φ 12 x 12 mm	120 x 1000 mm	80 mm



Art.	Sección	Largo
GD25/1	Φ 14 x 14 mm	120 x 1000 mm



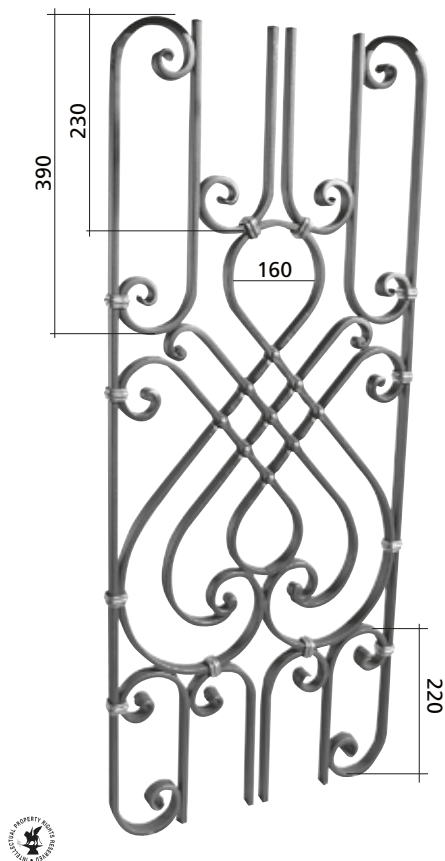
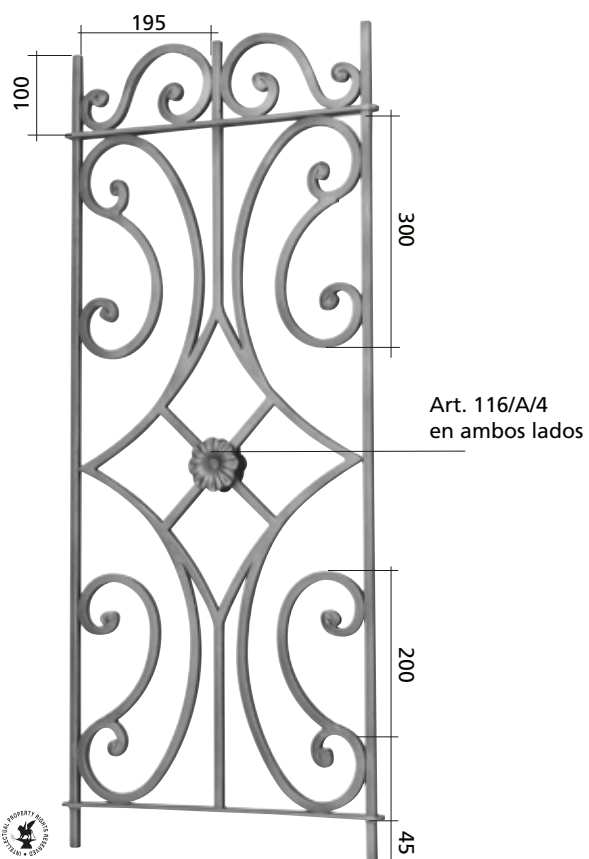

Art.	Sección	Largo
GD61/1	□ 12 x 12 mm	430 x 1000 mm

Art.	Sección	Largo
GD99/1	□ 16 x 8 mm	420 x 1000 mm



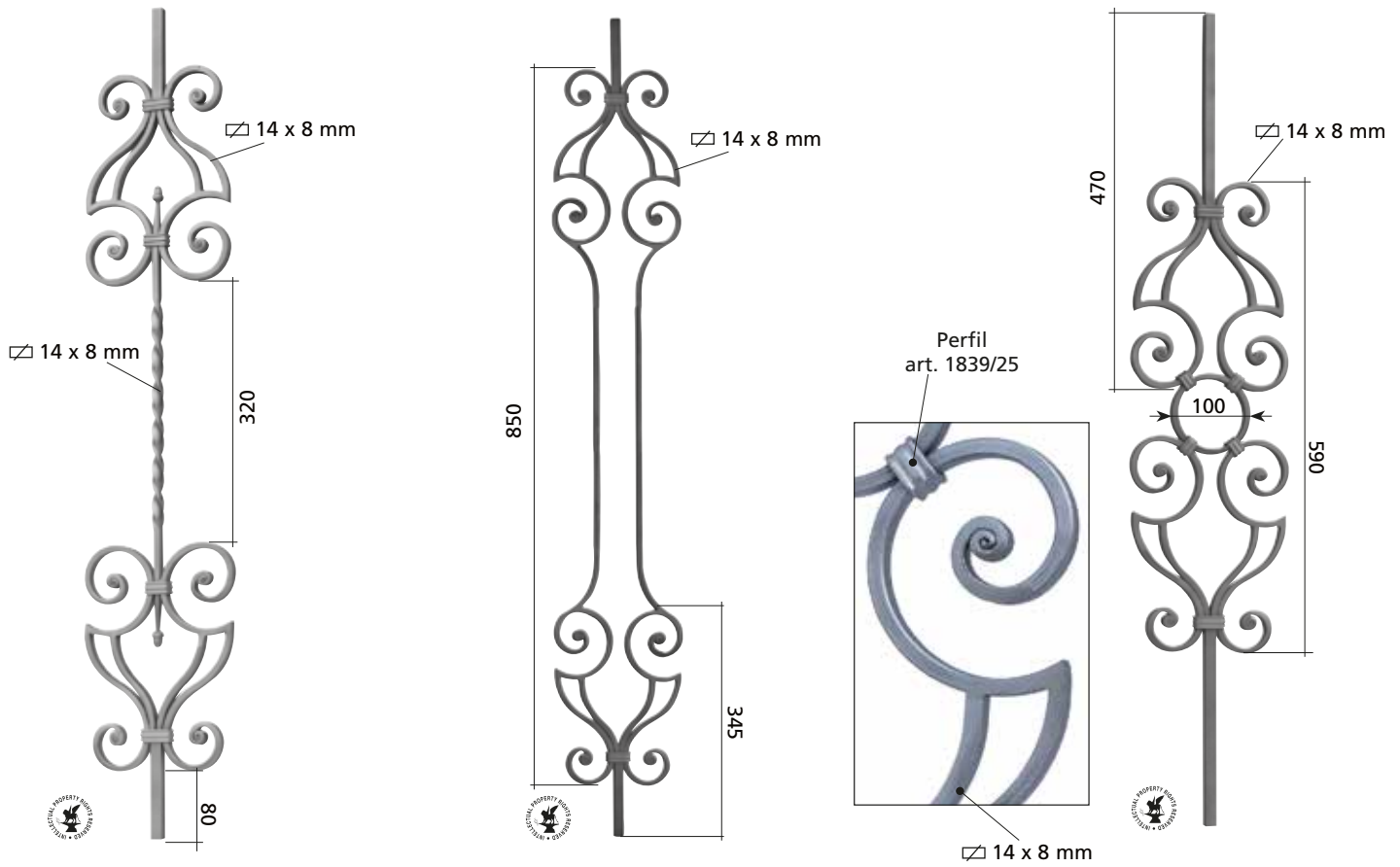

Art.	Sección	Largo
GD150/3	14 x 14 mm	190 x 1000 mm

Art.	Sección	Largo
GD150/2	14 x 14 mm	205 x 1000 mm

Art.	Sección	Largo
GD151/1	14 x 14 mm	205 x 1000 mm

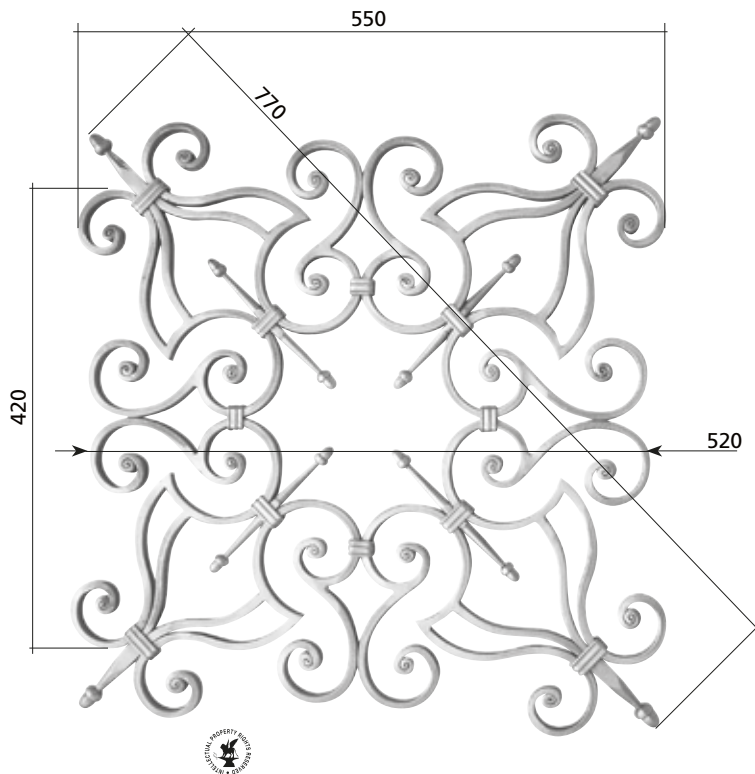

Art.	Sección	Largo
GD151/2	14 x 8 mm	550 x 550 mm





Art.	Sección	Largo
GD236/1	14 x 8 mm	970 x 1000 mm

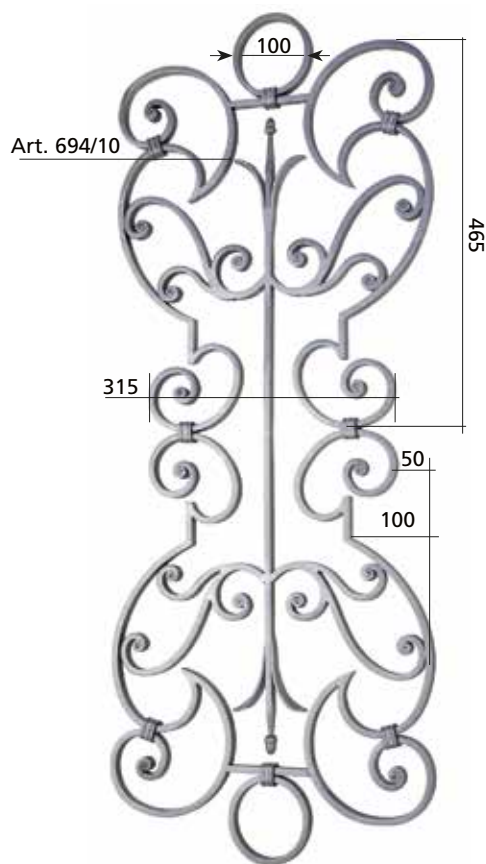

Art.	Sección	Largo
GD282/2	14 x 8 mm	405 x 1010 mm



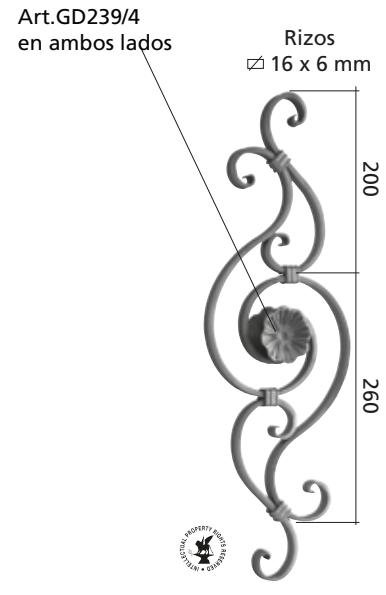
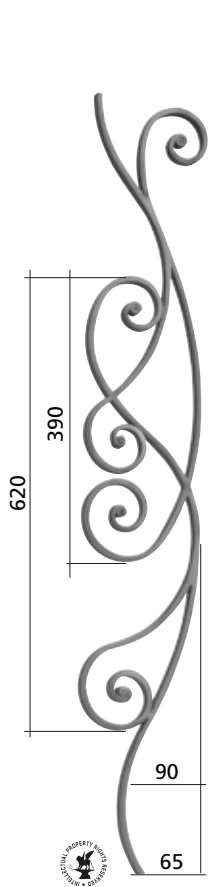

Art.	Sección	Largo
GD158/2	$\varnothing 14 \times 8 \text{ mm}$	160 x 1000 mm

Art.	Sección	Largo
GD271/5	$\varnothing 16 \times 8 \text{ mm}$	175 x 1000 mm

Art.	Sección	Largo
GD271/4	$\varnothing 16 \times 6 \text{ mm}$	175 x 510 mm



# arteferro

## SYSTEM

# SAFE DESIGN FOR PROJECTS

## LA IDEA

SEGURIDAD, DISEÑO, FACILIDAD Y VELOCIDAD DE INSTALACIÓN: ESTE ES EL SISTEMA CERTIFICADO ARTEFERRO

### SEGURIDAD



### DESIGN



### FÁCIL INSTALACIÓN



Al principio, nos preguntamos si era posible combinar belleza y seguridad en un producto como el hierro forjado, y encontramos la respuesta en la idea del diseño y la posterior producción arquitectónica del SISTEMA ARTEFERRO SYSTEM CERTIFICADO. Con el paso de los años, la seguridad se ha convertido, para nosotros y nuestros clientes, en sinónimo de profesionalidad y competencia. Impulsados por estas motivaciones, el equipo Arteferro, de acuerdo con la lógica del «think first, designing second», diseñó y pensó un sistema de barandillas certificadas y modulares, probadas en nuestros laboratorios con cargas de proyecto de 2 kN/m y empujes de hasta 3,5 kN/m de rotura. En el mundo en el que vivimos, donde el tiempo es la piedra angular de todo, las características que también debía poseer nuestro sistema tenían que ser la facilidad y velocidad de instalación. A partir de ahí, nació la idea de un módulo ya prefabricado, capaz de crear un agradable efecto estético sin necesidad de perder tiempo en la instalación. Gracias a esta característica, el profesional se encuentra con un módulo listo para su uso y que no requiere más soldadura, pintado o galvanizado. De hecho, nuestros paneles son completamente personalizables en cuanto a los materiales, colores y acabados.

El SISTEMA CERTIFICADO ARTEFERRO SYSTEM es la respuesta a esta idea y este es el catálogo que lo respalda.

Inmediatamente nos dimos cuenta de la frescura de las líneas, instaladas por expertos en ambientes con gran gusto estético.





# EL SISTEMA



TUTORIAL VIDEOS

PARA ALCANZAR LOS ESTÁNDARES  
LA CERTIFICACIÓN SIEMPRE ES OBLIGATORIA  
EL USO DE INSERTACIONES ROSCADAS

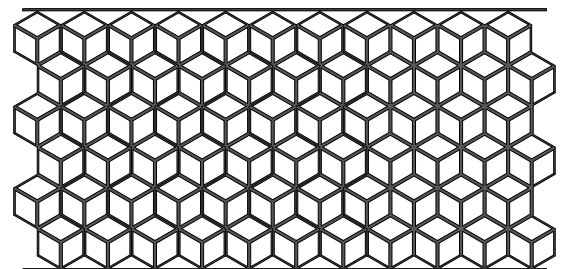
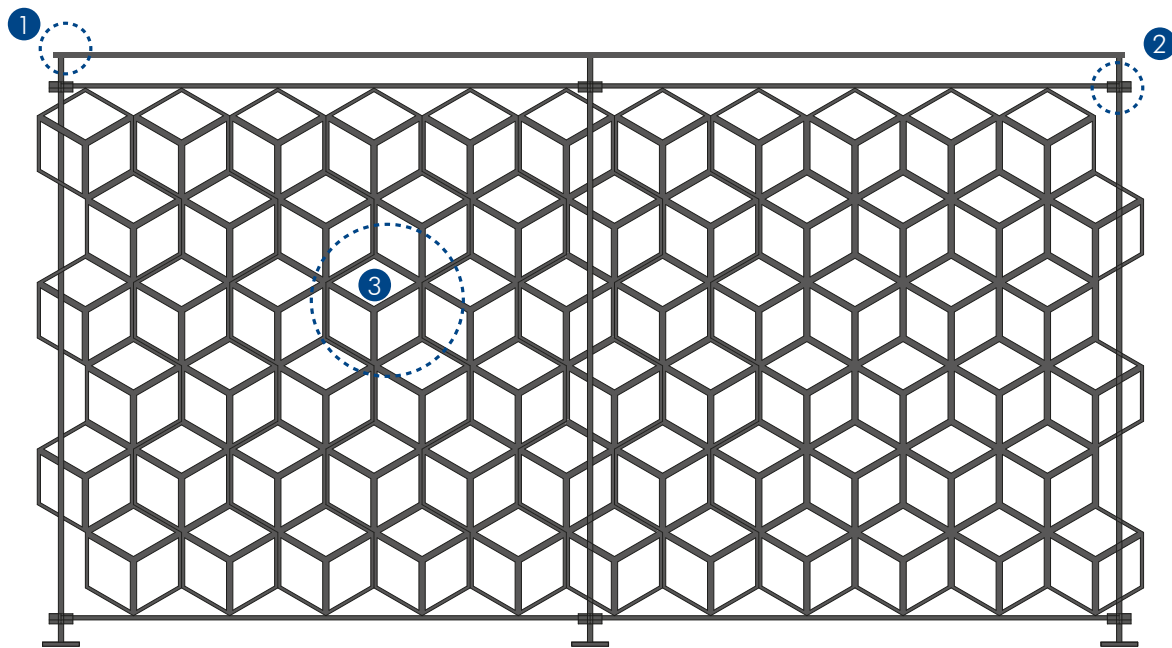

1

La columna ARTEFERRO SYSTEM es la estructura de soporte de nuestro sistema certificado que garantiza su sellado. Soporta esfuerzos de carga de 1 kN/m y 2 kN/m. Disponible en versión plana, redonda y cuadrada. Las dos últimas garantizan la posibilidad de añadir una barandilla desviada para asegurar el cumplimiento de las normativas actuales.

2

La pinza, el elemento de conexión entre el panel de relleno y la estructura de soporte, ha sido diseñada para adaptarse a diferentes tipos de columnas: planas, cuadradas y redondas. El hierro, material de construcción, aquí en versión negra micécea.

3

El relleno es la parte ornamental de nuestro sistema, con un diseño atemporal. Las líneas geométricas de la colección se funden sabiamente con los materiales utilizados. El hierro de este producto le da vida a un objeto que dialoga con el pasado y el futuro.







descarga el catálogo  
completo Railing Systems





Art.	Sección	Largo
126/13	Ø 16 base	64 x 170 mm
126/14	Ø 14 base	55 x 140 mm

Art.	Sección	Largo
126/1	Ø 10 x 10 mm	140 mm

Art.	Sección	Largo
126/2	Ø 20 x 20 mm	130 mm

Art.	Sección	Largo
126/C/7	Ø 18 mm	125 mm



Art.	Sección	Largo
125/1	Ø 35 mm	125 mm

Art.	Sección	Largo
125/2	Ø 14 x 14 mm	140 mm

Art.	Sección	Largo
725/1	Ø 30 mm	165 mm

Art.	Sección	Largo
1854/9	Ø 32 mm	180 mm





Art.	Sección	Largo
1855/6	Ø 26 mm	48 x 150 mm



Art.	Sección	Largo
727/10	Ø 33 mm	40 x 150 mm



Art.	Sección	Largo
727/11	Ø 30 mm	35 x 120 mm



Art.	Sección	Largo
124/1	base Ø 12 mm	125 mm
124/2	base Ø 15 mm	160 mm



Art.	Sección	Largo
122/A/1	Ø 35 mm	200 mm



Art.	Sección	Largo
126/B/1	base Ø 19 mm	82 x 195 mm
126/B/2	base Ø 16 mm	68 x 160 mm
126/B/3	base Ø 13 mm	54 x 130 mm



Art.	Sección	Largo
126/A/2	Ø 18 mm	43 x 100 mm



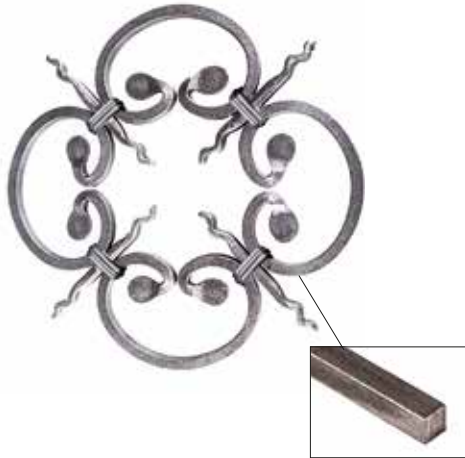

Art.	Sección	Dimensiones
16/1	8 x 8 mm	Ø 260 mm

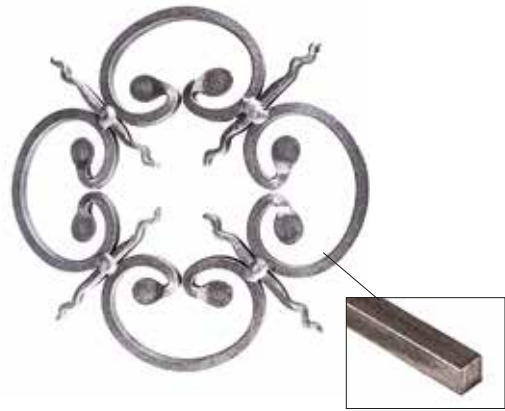

Art.	Sección	Dimensiones
16/2	8 x 8 mm	Ø 260 mm

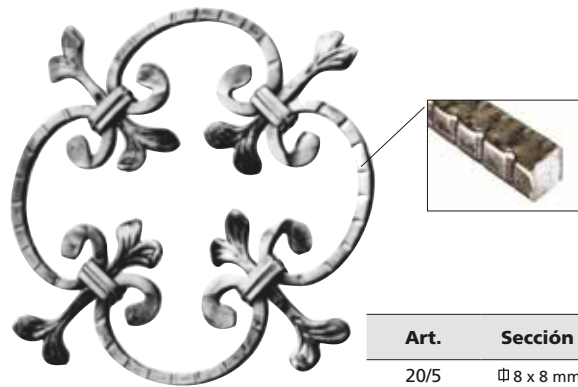

Art.	Sección	Dimensiones
20/5	8 x 8 mm	Ø 260 mm



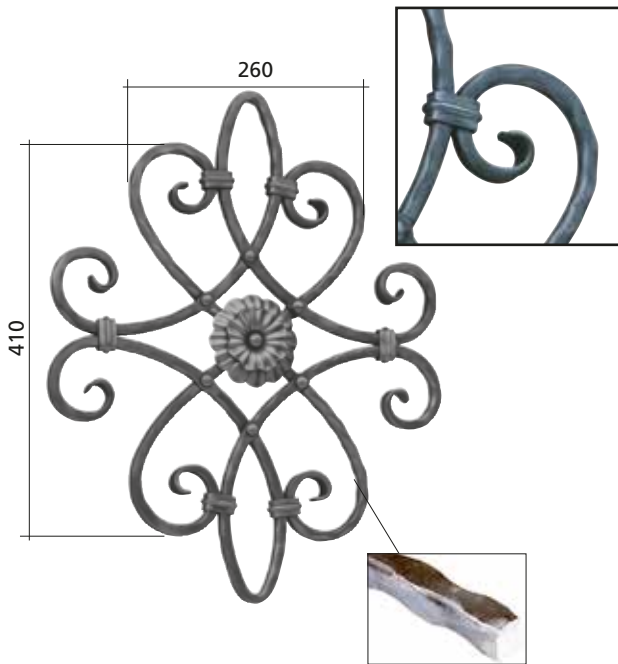

Martilleado

Art.	Sección	Dimensiones
26/C/1	□ 12 x 12 mm	430 x 530 mm

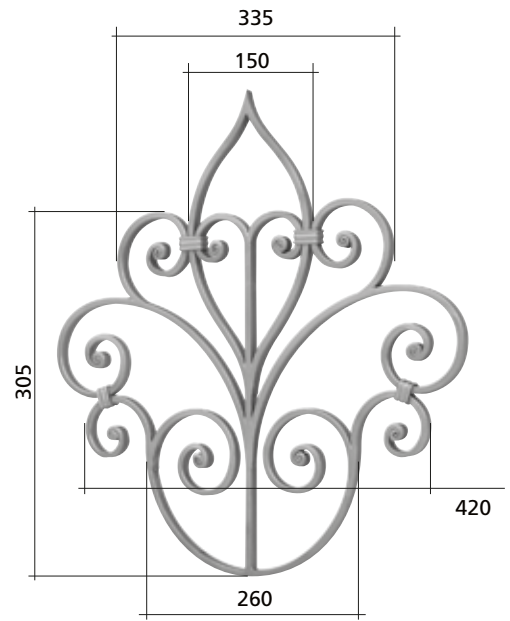

Art.	Sección	Dimensiones
GD234/2	□ 14 x 8 mm	500 x 520 mm



Art.	Sección	Dimensiones
31/1	□ 12 x 6 mm	∅ 225 mm



Fundición

Fundición

Art.	Sección	Dimensiones
34/1	□ 12 x 6 mm	350 x 350 mm



Terminación de cizalla en frío



Sección	Dimensiones 120 x 360 mm	Dimensiones 120 x 360 mm	Dimensiones 120 x 290 mm	Dimensiones 108 x 220 mm	Dimensiones 60 x 115 mm	Dimensiones 90 x 180 mm
12 x 6 mm	74/2	74/8	74/14	74/20	78/2	78/8
16 x 4 mm	74/3	74/9	74/15	74/21	78/3	78/9
20 x 4 mm	74/4	74/10	74/16	74/22	78/4	78/10

Terminación golpeado en caliente



Sección	Dimensiones 110 x 270 mm	Dimensiones 60 x 110 mm
12 x 6 mm	80/A/1	80/A/3
14 x 6 mm	80/A/28	80/A/29





Terminación golpeado en caliente



Sección	Dimensiones 70 x 105 mm	Dimensiones 95 x 140 mm	Dimensiones 65 x 150 mm	Dimensiones 70 x 190 mm
12 x 6 mm	80/A/9	80/A/10	80/A/11	80/A/12
14 x 6 mm	80/A/24	80/A/25	80/A/26	80/A/27

Terminación golpeado en caliente



Sección	Dimensiones 70 x 105 mm	Dimensiones 75 x 150 mm	Dimensiones 75 x 160 mm
12 x 6 mm	88/H/3	88/H/2	88/H/4



Art.	Sección	Dimensiones	Art.	Sección	Dimensiones
64/G/4	12 x 6 mm	60 x 105 mm	64/G/5	12 x 6 mm	60 x 105 mm





Esferas estampadas en caliente

Diámetro	Art.
Ø 20 mm	116/F/1
Ø 25 mm	116/F/2
Ø 30 mm	116/F/3
Ø 35 mm	123/1
Ø 40 mm	116/F/4
Ø 50 mm	116/F/5
Ø 60 mm	116/F/6
Ø 70 mm	116/F/7
Ø 80 mm	116/F/8
Ø 90 mm	116/F/9
Ø 100 mm	116/F/10
Ø 120 mm	116/F/17
Ø 150 mm	116/F/19

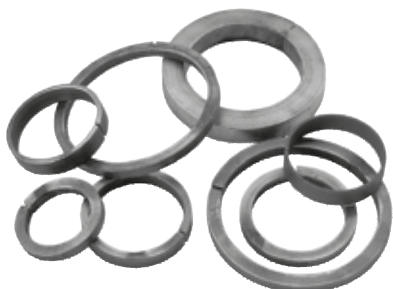

Sección	Art. ⌀ 12 x 12 mm	Art. ⊠ 12 x 6 mm	Art. ⊠ 20 x 4 mm
Ø 100 mm	491/8	157/1	157/6
Ø 115 mm	1317/1	157/2	157/7
Ø 130 mm	1317/2	157/3	157/8





Art.	Dimensiones	Agujero
128/8	Ø 40 x 65 mm	Ø 16,5 mm



Art.	Dimensiones	Agujero
128/19	Ø 40 x 39 mm	Ø 16,5 mm



Esferas estampadas en caliente

Art.	Dimensiones	Agujero
128/37	Ø 40 x 23 mm	redondo Ø 16,5 mm
128/2	Ø 40 x 23 mm	cuadrado 14,5 mm



Art.	Dimensiones	Agujero
1408/6	Ø 60 x 18 mm	Ø 31 mm

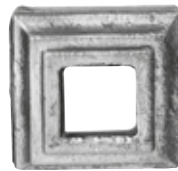

Art.	Dimensiones	Agujero
819/1	Ø 60 x 60 mm	14,5 mm



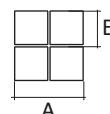

Art.	Diámetro	Largo	A	B
159/3	Ø 60 mm	125 mm	12 x 12 mm	6 x 6 mm
159/4	Ø 60 mm	125 mm	14 x 14 mm	7 x 7 mm
159/5	Ø 65 mm	145 mm	16 x 16 mm	8 x 8 mm
159/6	Ø 80 mm	165 mm	20 x 20 mm	10 x 10 mm
159/9	Ø 100 mm	220 mm	30 x 30 mm	15 x 15 mm

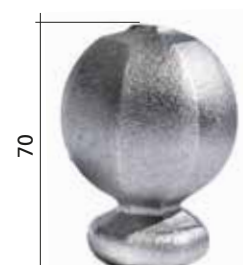
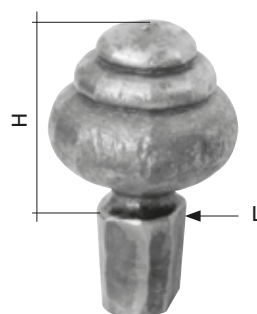

Art.	Dimensiones
113/10	Ø 70 mm

Art.	Dimensiones
113/9	Ø 75 mm

Art.	Diámetro	Dimensiones
116/A/19	Ø 55 mm	30 x 65 mm

Art.	Bola	Base
116/A/20	Ø 55 mm	Ø 38 mm

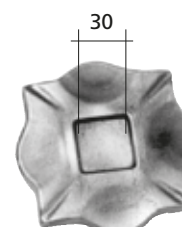
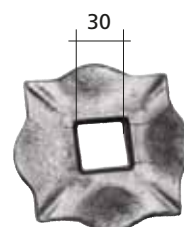

Art.	Sec.	Dim.
116/A/3	∇ 3 mm	Ø 95 mm

Art.	Sec.	Dim.
116/A/4	∇ 3 mm	Ø 65 mm

Art.	Sec.	Dim.
697/4	∇ 3 mm	Ø 65 mm

Art.	Sec.	Dim.
116/A/7	∇ 10 mm	100 x 100 mm

Art.	Sec.	Dim.
116/A/8	∇ 10 mm	100 x 100 mm





derecha

Art.	Sec.	Dim.
136/1	☒ 3 mm	40 x 110 mm



izquierda

Art.	Sec.	Dim.
136/2	☒ 3 mm	40 x 110 mm



derecha

Art.	Sec.	Dim.
136/3	☒ 3 mm	70 x 60 mm



izquierda

Art.	Sec.	Dim.
136/4	☒ 3 mm	70 x 60 mm



Art.	Sec.	Dim.
138/8	☒ 0,3 mm	28 x 60 mm



Art.	Sec.	Dim.
138/9	☒ 0,3 mm	35 x 70 mm



Art.	Sec.	Dim.
138/10	☒ 0,3 mm	45 x 85 mm



Art.	Dimensiones.
94/A/1	160 x 95 mm



Art.	Dimensiones.
94/A/2	160 x 95 mm



Art.	Sec.	Dim.
137/8	☒ 0,5 mm	50 x 90 mm



Art.	Dimensiones
140/H/1	270 x 130 mm



Art.	Dimensiones
140/H/2	170 x 90 mm

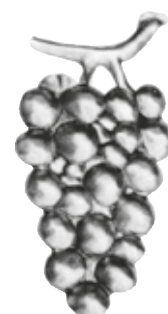

Art.	Sec.	Dim.
137/7	☒ 0,5 mm	60 x 130 mm

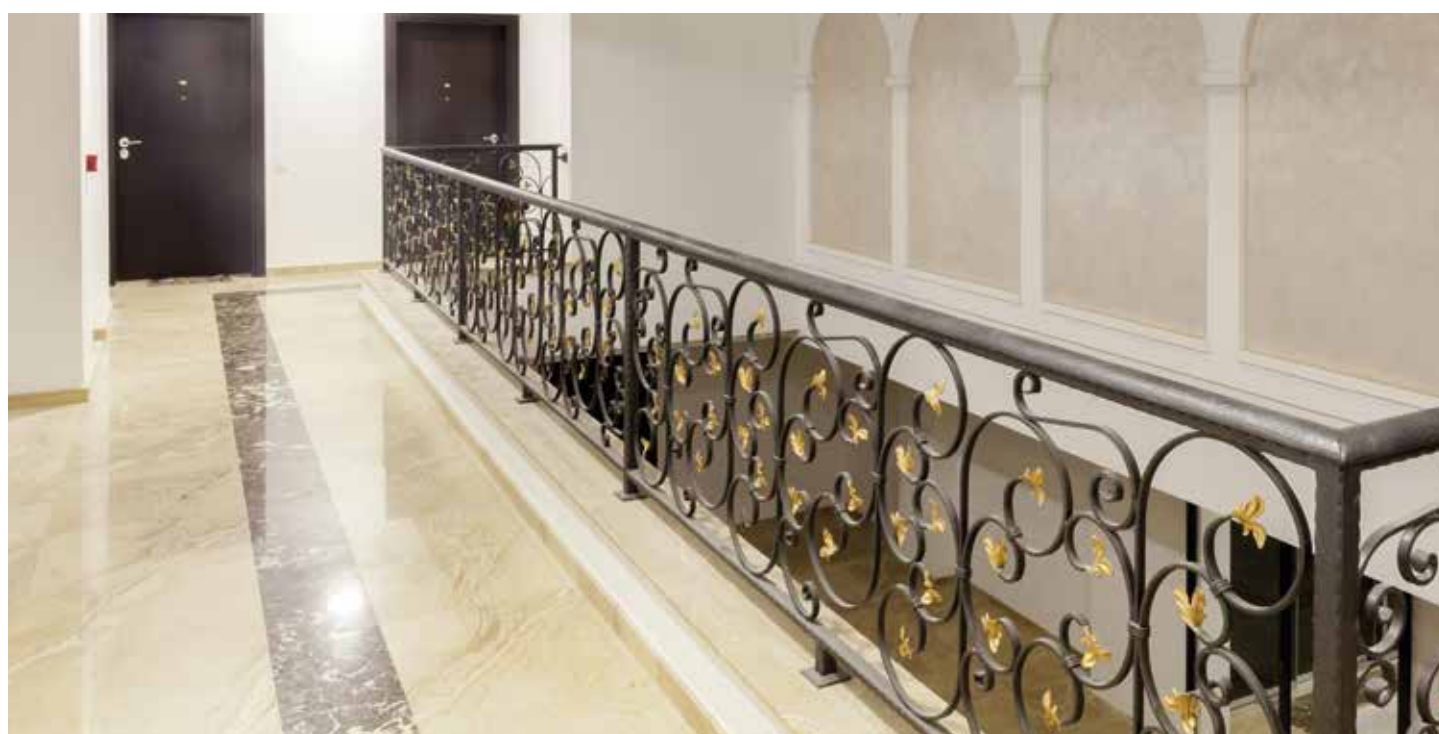

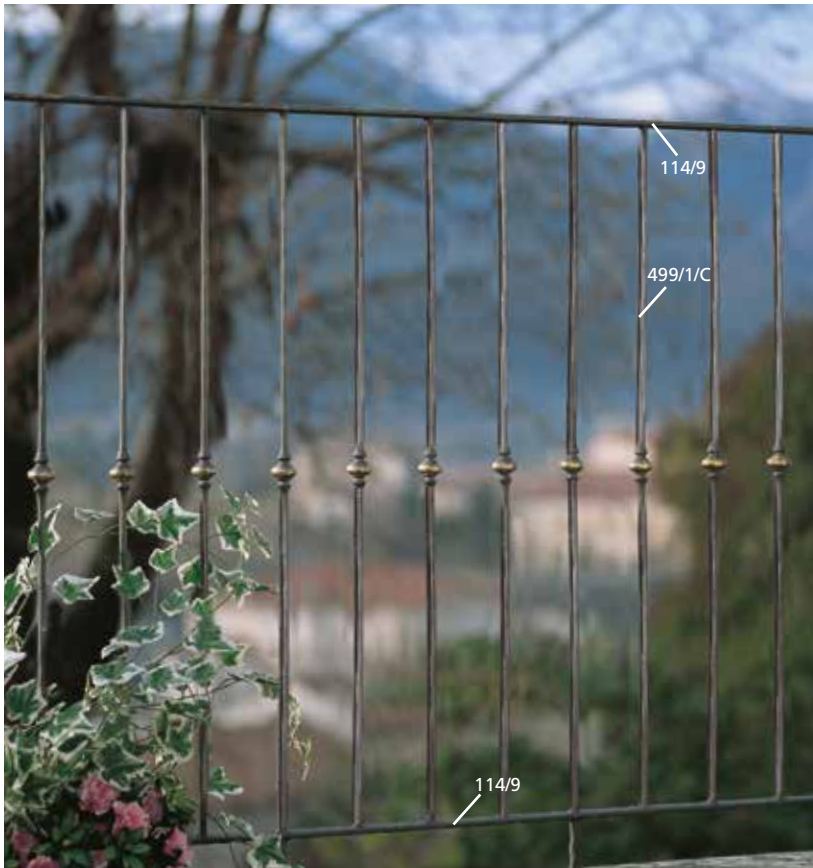

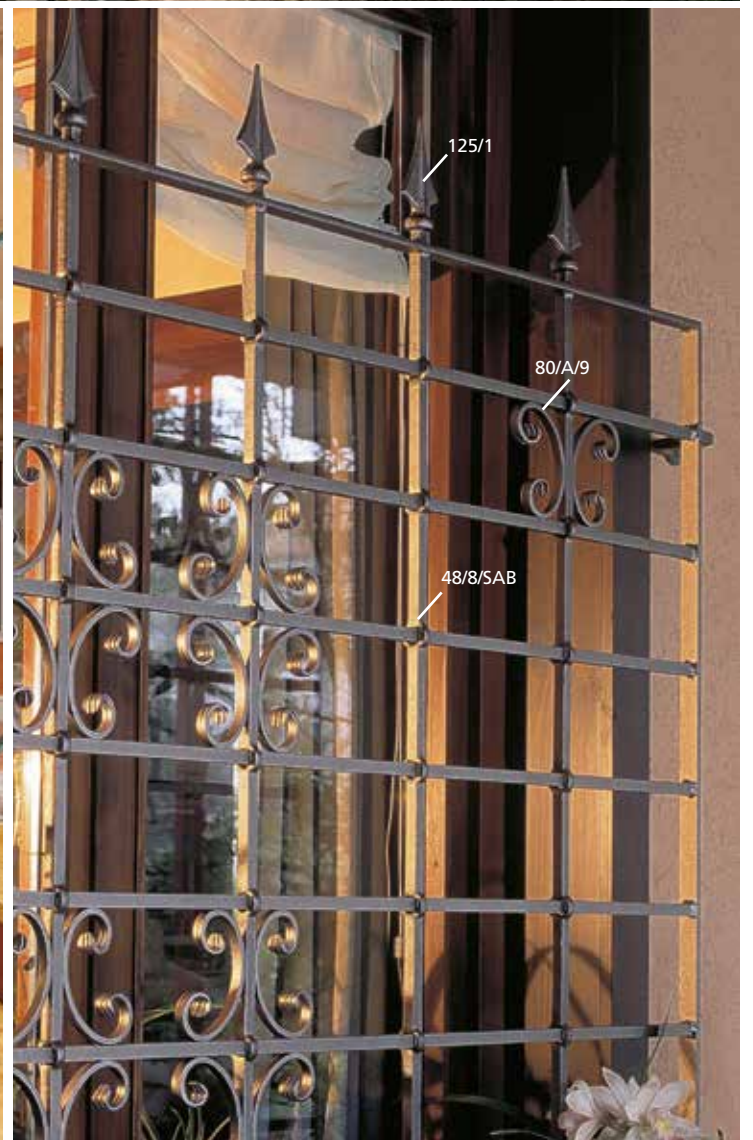

## GONZATO GROUP ESPAÑA

Ind.i.a. España, SL

C/ Abedul, 43 – Polig. Ind. El Guijar

28500 - Arganda del Rey

Madrid • España

tel. +34 918 700 819 • fax: +34 918 700 820

info@arteferro.es • www.arteferro.es



**GONZATO**  
GROUP